

SECTION 22 FLOOR WATERING PRICING

IN THIS CATALOG SECTION

PAGE NUMBER	CONTENTS
22-02	How to Order Floor Watering
22-03	Regulators
22-04	Intakes / Hose / End Assemblies / Flush Kits
22-05	Standpipe - Flex and Rigid
22-06	Lead-In Kits / Inline Shut Offs / Air Release
22-07	Filters / Water Meters / Medicator / Cleaners & Solutions / Line Shockers
22-08	Floor Watering Pipe Components - Pipe Assembly & Support Types
22-09	Floor Watering - Hanger Type / Support Drop Kits / Winching Cable
22-10	Floor Watering - Drinkers
22-11	Floor Watering - Accessories
22-12 thru 22-17	Drinker Descriptions, Identification Chart & Flow Rates
22-18	Floor Watering Option - Competitor Changeover & Replacement Items
22-19	Turkey Bell Drinkers
22-20 thru 22-21	Floor Kits - Big Tom Turkey
22-22	Floor Watering Options -Turkey Drinker / Mini Drinker / TruSeal / Replacement Standpipe / Misc.
22-23	Floor Watering Options - Conduit & Aluminum / PVC Pipe & Valves
22-24	Floor Watering Options - PVC Fittings
22-25	VR202 Regulator Repairs - VRP09 Intake
22-26	VR202 Regulator Repairs - RFV160 Intake
22-27	Regulator Installation With RFV160K 3-Position Intake - Automatic Flush
22-28	3-Position Flushing Intake Repairs
22-29	VR203 Regulator Repairs
22-30	VR204 Regulator Repairs
22-31	VR205 Regulator Repairs / VR209 Regulator Repair Parts
22-32 thru 22-33	Numerical Listing of Regulator Repairs
22-34	Filter Kit Repairs

FLOOR WATERING

HOW TO ORDER

CONTENTS

1. Determine type of bird, dimensions of house, and number of birds to be watered.
2. Using guidelines shown below, determine total number of watering lines and Drinkers needed to accommodate the number of birds in the house.
3. Select & order one floor regulator per line. Line length should not exceed 400' (122 m) If there is slope in the house, call for assistance in determining regulator needs.
4. Order correct number of watering pipe components after determining drinker spacing, type of support (conduit or aluminum extrusion), and type of Drinker needed.
5. Select and order one end assembly or automatic floor flush kit per line.
6. For each line, select and order other accessories as needed: winch & handle, Drinker drinker clip for breeders, trough mini drinker, etc.
7. For each house, select and order other accessories as needed: filter kit/backflush hookup, medicator & hookup kit, water meter, lead-in kit, standpipe bottle brush, shocking unit, etc.

BROILER GUIDELINES

- Brood area - recommended 30 birds per drinker up to 10 days old.
- Growout area - recommended 12-15 birds per drinker.
- Place water lines on both side of feed.
- Place water lines 2-3 ft. (61-91cm) from feed.
- Maximum line length is 400 ft. (122m).

BREEDER GUIDELINES

- All birds (male & female) - recommended 8-12 birds per drinker.
- Drinker spacing should never be less than 10" (24.5 cm)
- Place water lines 2-3' (61-91cm) from feed.
- Locking clip required on all Drinkers.
- Maximum line length is 400 ft. (122m).

TURKEY GUIDELINES

- For Big Tom Cup Drinker System:
 - 25 - 30 birds per drinker (0 - 6 weeks)
 - 20 birds per drinker (6 weeks +)
- Recommended density is 100 turkeys per TurkeyMax bell drinker, after six weeks to growout.
- Place water lines 2-3' (61-91cm) from feed.

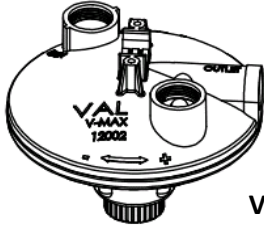

VR202

REGULATORS

V-MAX Regulator Ordering Instructions

1. Order the regulator.
2. Order the desired intake.
3. Order the desired standpipe.
4. Order the intake hose.

(3/4" for flush intake, 3/8" for old style intake.)

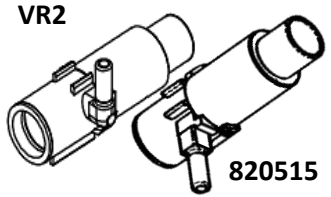

820515

V-MAX VR202 FLOOR REGULATOR KIT (requires 1 standpipe)

CATALOG #		ITEM DESCRIPTION	SHIP WEIGHT		LIST PRICE
Aluminum	Conduit		LBS.	KG.	
VR202KA	VR202KC	Regulator Kit with Anti-Tilt Bracket	1.90	0.86	
VR202KAPC	VR202KCPC	Regulator Kit without Anti-Tilt Bracket	1.80	0.82	

V-MAX VR202 QUICK KITS (Commonly ordered components packaged together) - (No Hose included)

CATALOG #		ITEM DESCRIPTION	SHIP WEIGHT		Alum./Cond. LIST PRICE
Aluminum	Conduit		LBS.	KG.	
820481	820489	Regulator Kit - VR202K, RFV160K, VSP30FS	4.47	2.03	
820482	820490	Regulator Kit - VR202K, VRP09K, VSP30FS	3.98	1.81	
820483	820491	Regulator Kit - VR202K, RFV160LK, VSP30FS	4.46	2.02	
820484	820492	Regulator Kit - VR202K, VRP09LK, VSP30FS	3.97	1.80	
820485	820493	Regulator Kit - VR202K, RFV160K, VSP24FS	4.68	2.12	
820486	820494	Regulator Kit - VR202K, VRP09K, VSP24FS	3.89	1.76	
820487	820495	Regulator Kit - VR202K, RFV160LK, VSP24FS	4.38	1.99	
820488	820496	Regulator Kit - VR202K, VRP09LK, VSP24FS	3.89	1.76	

V-MAX VR203 MID-LINE FLOOR REGULATOR (requires 1 standpipe)

CATALOG #		ITEM DESCRIPTION	SHIP WEIGHT		LIST PRICE
Aluminum	Conduit		LBS.	KG.	
VR203KA	VR203KC	Mid Line Regulator Kit with Anti-Tilt Bracket	1.80	0.82	
VR203KAPC	VR203KCPC	Mid Line Regulator Kit without Anti-Tilt Bracket	1.80	0.82	

V-MAX VR204 SLOPE REGULATOR (req. 2 standpipe - 1 must be 'K')

CATALOG #		ITEM DESCRIPTION	SHIP WEIGHT		LIST PRICE
Aluminum	Conduit		LBS.	KG.	
VR204KA	VR204KC	Slope Regulator Kit with Anti-Tilt Bracket	1.90	0.86	
VR204KAPC	VR204KCPC	Slope Regulator Kit without Anti-Tilt Bracket	1.80	0.82	

VR209 SLOPE REGULATOR

CATALOG #		ITEM DESCRIPTION	SHIP WEIGHT		LIST PRICE
Aluminum	Conduit		LBS.	KG.	
VR209-24A	VR209-24	Slope Regulator Kit With 24" Standpipe & Coupler	0.54	0.24	
VR209-30A	VR209-30	Slope Regulator Kit With 30" Standpipe & Coupler	0.56	0.25	
VR209P		Slope Regulator Only - Automatic Flush Thru	0.18	0.08	
VR209S		Air Release with "L" Stem	0.11	0.05	
820513		Air Release with Side Exit Stem	0.10	0.05	
820515		Slope Regulator Only - with Side Exit Stem	0.17	0.08	
820516		Slope Regulator Only - with Side Stem Plug	0.17	0.08	
VRP90		Slope Regulator - Left Kit for VR209	0.11	0.05	

All VR209 slope regulators include spring and S-bracket or pipe clip. Fold-over standpipe is not available for VR209 slope regulators.

VR205 HIGH PRESSURE REGULATOR

CATALOG #		ITEM DESCRIPTION	SHIP WEIGHT		LIST PRICE
Aluminum	Conduit		LBS.	KG.	
VR205		High Pressure Regulator Kit - No Gauges	2.16	0.98	
VR205-1		High Pressure Regulator Kit - 1 Gauge	2.65	1.20	
VR205-2		High Pressure Regulator Kit - 2 Oil Filled Pressure Gauges	3.14	1.42	

Maximum Incoming Pressure: 100 PSI

Pressure Range: 25 PSI Minimum

INDIVIDUAL REGULATOR

CATALOG #		ITEM DESCRIPTION	SHIP WEIGHT		LIST PRICE
Aluminum	Conduit		LBS.	KG.	
12002		V-MAX Regulator only for VR202K	1.48	0.67	
12003		V-MAX Regulator only for VR203K	1.60	0.73	
12004		V-MAX Regulator only for VR204K	1.60	0.73	

<p align="center">STANDARD</p> <p>Maximum Incoming Pressure 15-75 PSI</p> <p>Pressure Range 0-1 PSI or 0-28" Water Column</p>	<p>INTAKE KITS</p> 	<p align="center">LOW PRESSURE</p> <p>Maximum Incoming Pressure 3-15 PSI</p> <p>Pressure Range 0-1 PSI or 0-28" Water</p>
--	--	--

INTAKE KITS		SHIP WEIGHT		LIST PRICE
CATALOG #	ITEM DESCRIPTION	LBS.	KG.	
RFV160K	Inlet Kit, Flushing, Shut Off (incl. (2) PMTT6, VRP66, VRP67S, (2) PMHC3-4)	0.62	0.28	
RFV160LK	Inlet Kit, Flushing, Shut off, Low pressure (incl. same parts as RFV160K)	0.66	0.30	
VRP09K	Inlet Kit, Shut off (incl. (2) VRP45 & (2) VRP375)	0.16	0.07	
VRP09LK	Inlet Kit, Shut off, low pressure (incl. (2) VRP45 & (2) VRP375)	0.16	0.07	

INDIVIDUAL INTAKE			
RFV160	Regulator Flushing Intake only	0.41	0.18
RFV160L	Regulator Flushing Intake only - Low Pressure	0.41	0.18
VRP09	Shutoff Intake only	0.13	0.06
VRP09L	Shutoff Intake only - Low Pressure	0.09	0.04
VRP30F	Shutoff Intake with Flex Standpipe Connection	0.12	0.05

HOSE			
VRP79-Q300	PVC Yellow Regulator drop HOSE, 3/8" ID (Unit of measure: 300 Foot Roll) For use with new style flush intake. (RFV160)	66.20	30.03
VRP79	PVC Yellow Regulator drop HOSE, 3/8" ID (Unit of measure: Per foot) For use with new style flush intake. (RFV160)	0.22	0.10
VRP48-Q500	PVC Yellow Regulator Drop Hose, 3/8" (Unit of measure: 500 Foot Roll) For use with old style intake. (VRP09)	39.60	17.96
VRP48	PVC Yellow Regulator Drop Hose, 3/8" (Unit of measure: per foot) For use with old style intake. (VRP09)	0.08	0.04

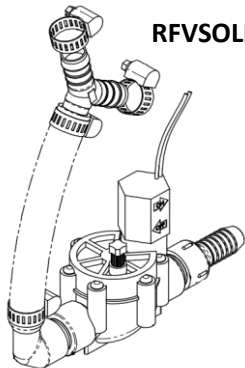

RFVSOLFLUSHKIT

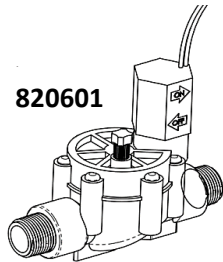

820601

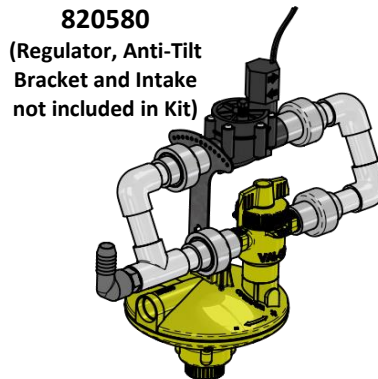

820580
(Regulator, Anti-Tilt Bracket and Intake not included in Kit)

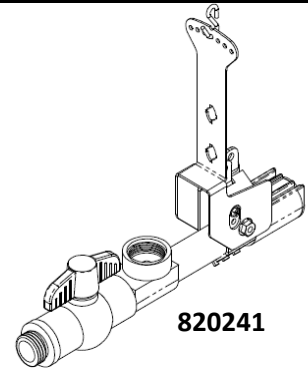

820241

END ASSEMBLIES (requires 1 standpipe)		SHIP WEIGHT		LIST PRICE
CATALOG #	ITEM DESCRIPTION	LBS.	KG.	
820241	End Assembly Kit, Manual US GHA	1.18	0.54	
820241PC	End Assembly Kit manual US GHA - without Anti-Tilt Bracket	1.00	0.45	
820242	End Assembly Kit manual SI GHA	1.26	0.57	
820242PC	End Assembly Kit manual SI GHA - without Anti-Tilt Bracket	1.00	0.45	

FLOOR FLUSH KIT			
RFVSOLFLUSHKIT	24vdc Solenoid flush kit with Hose	1.32	0.60
820580	24vdc Solenoid flush kit with PVC (Regulator, Bracket and Intake not included)	1.90	0.86
820601	24vdc Solenoid with 3/4" MNPT	0.78	0.35
VF200	Automatic Floor Flush Kit US GHA - 1 Line (End of line)	1.68	0.8
VF202	Automatic Floor Flush Kit US GHA - 2 Line (End of line)	2.38	1.08
VF200M	Automatic Floor Flush Kit SI GHA - 1 Line (End of line)	1.68	0.76
VF202M	Automatic Floor Flush Kit SI GHA - 2 Line (End of line)	2.43	1.10

VF 200 and VF202 Flush Kits include clear hose, spring, holding bracket, 3/4" ball valve and all plumbing fittings needed; drain pipe not included.

FLEX STANDPIPE

Foldover Standpipes		SHIP WEIGHT		LIST PRICE
		LBS.	KG.	
CATALOG #	ITEM DESCRIPTION			
VSP18FO	FLEX SP ASSY, 18", FOLD OVER	0.44	0.20	
VSP24FO	FLEX SP ASSY, 24", FOLD OVER	0.50	0.23	
VSP30FO	FLEX SP ASSY, 30", FOLD OVER	0.47	0.21	
Shutoff Standpipes				
VSP18FS	FLEX SP ASSY, 18", SHUTOFF	0.36	0.16	
VSP24FS	FLEX SP ASSY, 24", SHUTOFF	0.50	0.22	
VSP30FS	FLEX SP ASSY, 30", SHUTOFF	0.57	0.26	
1/2" NPT Standpipes				
VSP18FK	FLEX SP ASSY, 18", INTAKE	0.35	0.16	
VSP24FK	FLEX SP ASSY, 24", INTAKE	0.44	0.20	
VSP30FK	FLEX SP ASSY, 30", INTAKE	0.46	0.21	
Shutoff with Barb and Hose Clamp				
VSP24FF	FLEX SP ASSY, 24", SHUTOFF with Barb and Hose Clamp	0.53	0.24	
VSP30FF	FLEX SP ASSY, 30", SHUTOFF with Barb and Hose Clamp	0.53	0.24	

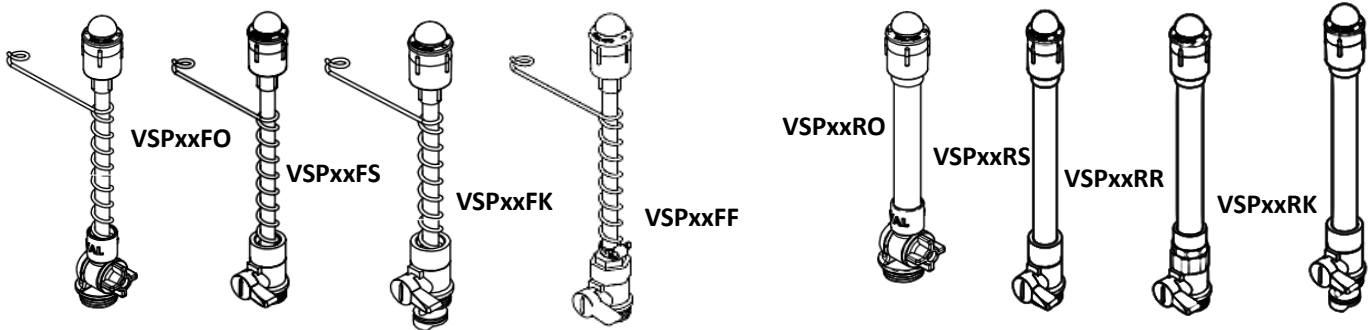

RIGID STANDPIPE

Foldover Standpipes		SHIP WEIGHT		LIST PRICE
		LBS.	KG.	
CATALOG #	ITEM DESCRIPTION			
VSP12RO	RIGID SP ASSY, 12", FOLD OVER	0.22	0.10	
VSP18RO	RIGID SP ASSY, 18", FOLD OVER	0.33	0.15	
VSP24RO	RIGID SP ASSY, 24", FOLD OVER	0.37	0.17	
VSP30RO	RIGID SP ASSY, 30", FOLD OVER	0.40	0.18	
VSP36RO	RIGID SP ASSY, 36", FOLD OVER	0.38	0.17	
Shutoff Standpipes				
VSP12RS	RIGID SP ASSY, 12", SHUTOFF	0.30	0.14	
VSP18RS	RIGID SP ASSY, 18", SHUTOFF	0.32	0.15	
VSP24RS	RIGID SP ASSY, 24", SHUTOFF	0.40	0.18	
VSP30RS	RIGID SP ASSY, 30", SHUTOFF	0.32	0.14	
VSP36RS	RIGID SP ASSY, 36", SHUTOFF	0.36	0.16	
1/2" NPT Standpipes				
VSP12RR	RIGID SP ASSY, 12", 1/2" NPT	0.24	0.11	
VSP18RR	RIGID SP ASSY, 18", 1/2" NPT	0.29	0.13	
VSP24RR	RIGID SP ASSY, 24", 1/2" NPT	0.40	0.18	
VSP30RR	RIGID SP ASSY, 30", 1/2" NPT	0.39	0.18	
VSP36RR	RIGID SP ASSY, 36", 1/2" NPT	0.44	0.20	
Intake Standpipes				
VSP12RK	RIGID SP ASSY, 12", INTAKE	0.21	0.10	
VSP18RK	RIGID SP ASSY, 18", INTAKE	0.25	0.11	
VSP24RK	RIGID SP ASSY, 24", INTAKE	0.29	0.13	
VSP30RK	RIGID SP ASSY, 30", INTAKE	0.33	0.15	
VSP36RK	RIGID SP ASSY, 36", INTAKE	0.37	0.17	

BRUSHES FOR STANDPIPES

VB151	Bottle Brush for Rigid Standpipe	0.11	0.05	
VB151F	Bottle Brush for Flex Standpipe	0.11	0.05	

FLOOR WATERING OPTIONS

LEAD-IN KITS

CATALOG #	ITEM DESCRIPTION	SHIP WEIGHT		LIST PRICE
		LBS.	KG.	
VL902	Lead-In Kit for 2 Watering Lines [VP001(10), VC146(5),VT100, VT102(6), VT134(2)]	14.54	6.60	
VL903	Lead-In Kit for 3 Watering Lines [VP001(11), VC146(5),VT100, VT101, VT102(6), VT134(2)]	15.90	7.21	
VL904	Lead-In Kit for 4 Watering Lines [VP001(12), VC146(5),VT100, VT101(2), VT102(6), VT134(2)]	17.21	7.81	
VL905	Lead-In Kit for 5 Watering Lines [VP001(13), VC146(5),VT100, VT101(3), VT102(6), VT134(2)]	18.55	8.41	
VL906	Lead-In Kit for 6 Watering Lines [VP001(15), VC146(5),VT100, VT101(4), VT102(6), VT134(2)]	21.12	9.58	
VL907	Lead-In Kit for 7 Watering Lines [VP001(16), VC146(5),VT100, VT101(5), VT102(6), VT134(2)]	22.46	10.19	
VL908	Lead-In Kit for 8 Watering Lines [VP001(18), VC146(5),VT100, VT101(6), VT102(6), VT134(2)]	25.04	11.36	

INLINE SHUTOFF ASSEMBLIES

CATALOG #	ITEM DESCRIPTION	SHIP WEIGHT		LIST PRICE
		LBS.	KG.	
VS324F	Inline Shutoff Assy - 24" Flexible Standpipe - for Conduit	0.78	0.35	
VS324FA	Inline Shutoff Assy - 24" Flexible Standpipe - for Alum Extrusion	0.74	0.33	
VS330F	Inline Shutoff Assy - 30" Flexible Standpipe - for Conduit	0.79	0.36	
VS330FA	Inline Shutoff Assy - 30" Flexible Standpipe - for Alum Extrusion	0.73	0.33	
VV802	3/4" Ball Valve With Pipe Or Extrusion Clearance	0.24	0.11	

All inline shutoff assemblies include standpipe (with spring, shutoff ball and shutoff cap), 3/4" ball valve, and pipe clip or S hanger bracket.

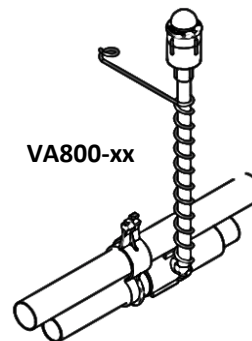
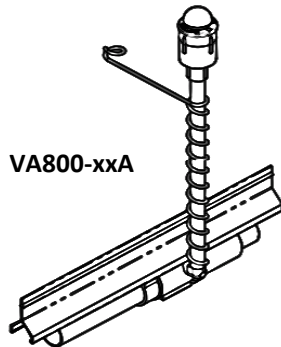

AIR RELEASES

CATALOG #	ITEM DESCRIPTION	SHIP WEIGHT		LIST PRICE
		LBS.	KG.	
VA800-24	Air Release With Auto Shutoff & 24" Flex Standpipe - Conduit	0.71	0.32	
VA800-24A	Air Release With Auto Shutoff & 24" Flex Standpipe - Aluminum Extrusion	0.68	0.31	
VA800-30	Air Release With Auto Shutoff & 30" Flex Standpipe - Conduit	0.74	0.33	
VA800-30A	Air Release With Auto Shutoff & 30" Flex Standpipe - Aluminum Extrusion	0.70	0.32	
VR209S	Left Body Only - for Air Release & Slope Regulator	0.11	0.05	

FLOOR WATERING OPTIONS

FILTER KIT/BACKFLUSH

CATALOG #	ITEM DESCRIPTION	SHIP WEIGHT		LIST PRICE
		LBS.	KG.	
VF122	Filter Kit/Backflush Hookup	9.25	4.20	
VF122L	Filter Kit/Backflush Hookup - Low Pressure	9.03	4.10	
VF122-H	Filter Kit - Without Hookup or Gauges(30 Micron Filter)	6.95	3.15	
VF122L-H	Filter Kit - W/O Hookup or Gauges - Low Pressure (50 Micron Filter)	6.74	3.06	

WATER METERS *(kits includes [2] VT132 -3/4" PVC female adapter S X thread)*

CATALOG #	ITEM DESCRIPTION	SHIP WEIGHT		LIST PRICE
		LBS.	KG.	
820370	WATER METER KIT, GAL, LOCAL, 5/8"X3/4", Brass Body, Line Size 3/4"	8.00	3.6	
820371	WATER METER KIT, GAL, DIGITAL, 5/8"X3/4", Brass Body, Line Size 3/4"	8.00	3.6	
820372	WATER METER KIT, MET, LOCAL, 5/8"X3/4", Brass Body, Line Size 3/4"	8.00	3.6	
820373	WATER METER KIT, MET, DIGITAL, 5/8"X3/4", Brass Body, Line Size 3/4"	8.00	3.6	
820374	WATER METER KIT, GAL, LOCAL, 5/8" X 3/4", Plastic Body, Line Size 3/4"	8.00	2.7	
820375	WATER METER KIT, GAL, DIGITAL, 5/8" X 3/4", Plastic Body, Line Size 3/4"	3.10	2.7	
820376	WATER METER KIT, MET, LOCAL, 5/8" X 3/4", Plastic Body, Line Size 3/4"	8.00	2.7	
820377	WATER METER KIT, MET, DIGITAL, 5/8" X 3/4", Plastic Body, Line Size 3/4"	8.00	2.7	
820284	PVC Adapter, 1" X 3/4", slip x slip, schedule 40	0.10	0.05	
VT100	3/4" PVC Tee S X S X S	0.01	0.00	
VT102	3/4" PVC 90 ELL S X S	0.08	0.04	
VT132	3/4" PVC Female Adapter S X Thread	0.05	0.02	
VV801	3/4" Ball Valve	0.24	0.11	
VX127	3/4" Union S X S	0.16	0.07	

MEDICATOR

CATALOG #	ITEM DESCRIPTION	SHIP WEIGHT		LIST PRICE
		LBS.	KG.	
VM501	Dosatron Medicator Kit (D25RE2) - Dilution Range 1:500 to 1:50 (.2% to 2%)	3.41	1.55	
820341	Dosatron Medicator Kit (D25RE5) - Dilution Range 1:100 to 1:20 (1% to 5%)	4.00	1.81	
VM515	Dosatron Medicator Kit (D128R) - Dilution Range 1:200/1:128/1:100 (0.5% to 1%)	0.00	0.00	
VM507	Hook-Up Kit for Medicator	1.75	0.79	
VM504	D25RE2 Rebuild Kit	44.00	19.96	
VM511	Seal Replacement Kit for D25RE2	0.20	0.09	

Medicators can be used in high or low pressure systems from 4.3-85 PSI (.3-5.86 Bar).

CLEANERS / SOLUTIONS

CATALOG #	ITEM DESCRIPTION	SHIP WEIGHT		LIST PRICE
		LBS.	KG.	
VC200	Pro Clean (1 Gal)	4.75	2.15	
PM10TS	10TS Water Treatment System	25.00	11.34	
PMCPABU1	Water Treatment Solution - 5 Gallon (PARAFOS)	50.00	22.68	

LINE SHOCKERS - International Sales Only

CATALOG #	ITEM DESCRIPTION	SHIP WEIGHT		LIST PRICE
		LBS.	KG.	
820461	Shocker Unit - 50/60Hz - 110V - Pulsating, 0.2 Joules Output	3.00	1.36	
820458	Shocker Unit - 50/60Hz - 220V - Pulsating, 0.2 Joules Output	2.82	1.28	

VAL-CO FLOOR WATERING PIPE COMPONENTS

DETERMINE CATALOG NUMBERS TO ORDER PIPE COMPONENTS

Select Pipe Components

1	2	3	4	5	6	7
Pipe Assembly	Support Type	Hanger Type	Support Drop Kits	Winching Cable	Nipple Drinker	Optional Accessories

1. Pipe Assembly

NUMBER OF Drinker DRINKERS	DRINKER SPACING		Ship Weight		Universal Saddle Assemblies		Standard Saddle Assemblies		Side Saddle Assemblies	
	IN	CM	LBS.	KG.	Part Number	List Price	Part Number	List Price	Part Number	List Price
3	40.0	101.6	1.0	0.4	VKP03		VKP03S		VKS03	
4	30.0	76.2	1.0	0.5	VKP04		VKP04S		VKS04	
5	24.0	61.0	1.0	0.5	VKP05		VKP05S		VKS05	
6	20.0	50.8	1.0	0.5	VKP06		VKP06S		VKS06	
7	17.1	43.5	1.0	0.5	VKP07		VKP07S		VKS07	
8	15.0	38.1	1.1	0.5	VKP08		VKP08S		VKS08	
9	13.3	33.9	1.1	0.5	VKP09		VKP09S		VKS09	
10	12.0	30.5	1.1	0.5	VKP10		VKP10S		VKS10	
11	10.9	27.7	1.1	0.5	VKP11		VKP11S		VKS11	
12	10.0	25.4	1.1	0.5	VKP12		VKP12S		VKS12	
13	9.2	23.4	1.1	0.5	VKP13		VKP13S		VKS13	
14	8.3	21.8	1.1	0.5	VKP14		VKP14S		VKS14	
15	8.0	20.3	1.1	0.5	VKP15		VKP15S		VKS15	
16	7.5	19.1	1.2	0.5	VKP16		VKP16S		VKS16	
17	7.1	17.9	1.2	0.5	VKP17		VKP17S		VKS17	
18	6.7	16.9	1.2	0.5	VKP18		VKP18S		VKS18	
19	6.3	16.0	1.2	0.5	VKP19		VKP19S		VKS19	
20	6.0	15.2	1.2	0.5	VKP20		VKP20S		VKS20	
25	4.8	12.2	1.2	0.6	VKP25		VKP25S		VKS25	

Pipe Assemblies include Val-Co Watering Pipe with Saddles & Coupler attached

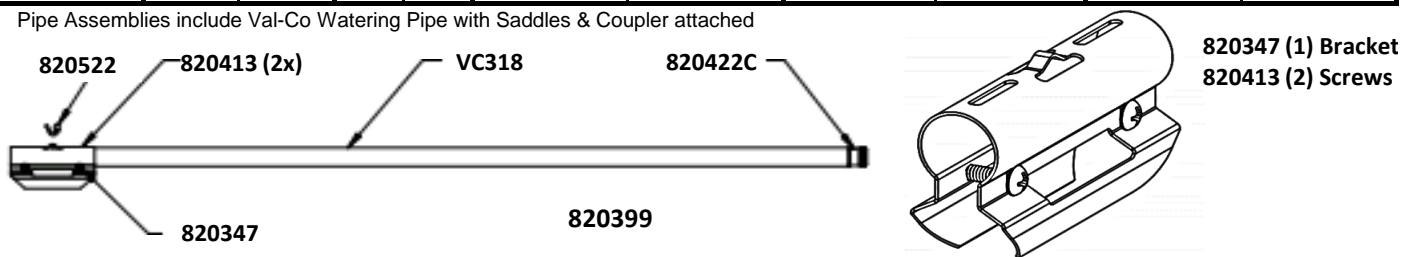

2. Support Type (1 per Pipe Assembly)

Part Number	Description	Ship Weight		List Price
		LBS.	KG.	
VA316	Aluminum Extrusion Kit <i>(Includes: VA317 - Connector, VA318 - Extrusion & VA319 [2] - Screws)</i>	2.25	1.02	
VC316	1.163" OD Conduit Kit <i>(Includes: VC318- Conduit & VC317 - Connector)</i>	2.25	1.02	
820399	1.163" OD Conduit with Anti-Rotational Bracket Kit <i>(Includes: VC318 - Conduit, 820347 Anti-Rotational Coupler, 820413 [2] - Screws, 820422C - Coupler & 820522 - Hook)</i>	2.25	1.02	

RECOMMENDED DENSITY PER Drinker

• Broilers - 15 • Breeders - 12 • Ducks - 10

3. Hanger Type

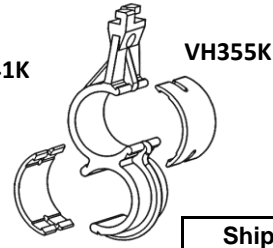
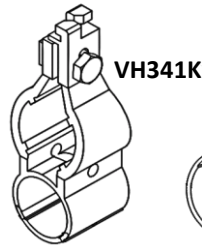
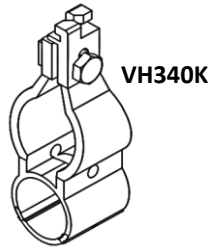

Part Number	Description	Ship Weight		List Price
		LBS.	KG.	
VA500	Pipe Clip - Val-Co Aluminum Extrusion (6 per 10' pipe section)	0.01	0.00	
VA500-Q6	VA500 Pipe Clip - Quantity of 6 - (6 per 10' pipe section)	0.08	0.03	
VA500-Q30	VA500 Pipe Clip - Quantity of 30 - (6 per 10' pipe section)	0.38	0.17	
VA500-Q60	VA500 Pipe Clip - Quantity of 60 - (6 per 10' pipe section)	0.76	0.35	
VA505	Pipe Clip - ChoreTime & Lubing Alum. Extrusion - (6 per 10' pipe section)	0.01	0.00	
VH340K	Clamp Hanger Bracket Kit for 1" Conduit	0.05	0.02	
VH341K	Ribbed Hanger Bracket for 3/4" Pipe Kit	0.04	0.02	
VH355K	S-Hanger Bracket Kit for 1" Conduit	0.06	0.03	

VA500 & VA505 - 6 per 10' Pipe Section
 All Others - 5 per 10' Pipe Section

4. Support Drop Kits



VA600



VE345



VA601

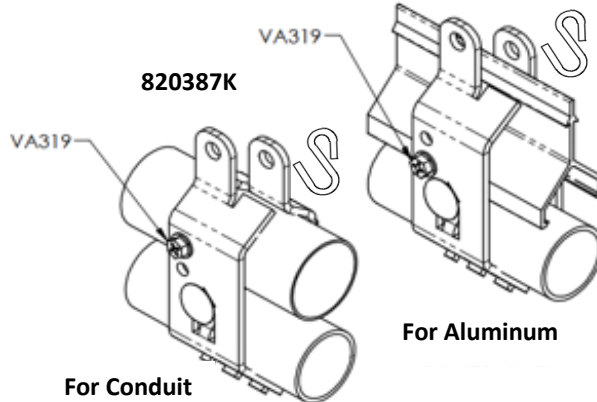

For Conduit

For Aluminum



VEN91104

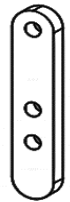

VS341

Part Number	Description	Ship Weight		List Price
		LBS.	KG.	
820410	Aluminum Extrusion Support Drop Kit (Includes: VA600, VD319 [10ft cord], VEN91104, VE345 Sta-Kon & VS341)	0.21	0.10	
820421	Aluminum Extrusion Support Drop Kit without Winching (Includes: VA600 & VS341)	0.02	0.01	
820423	Aluminum Extrusion Winch Kit, with Shocker Wire Option (Includes: VA601 [5], VD319 [10ft cord], VEN91104, VE345 Sta-Kon & VS341)	0.30	0.14	
820411	Conduit Winch Kit (Includes: VD319 [10ft cord], VEN91104, VE345 Sta-Kon & VS341)	0.16	0.07	
820412	Conduit Perch Winch Kit (Includes: VEN91104, VE345 Sta-Kon, 820387K, VD319 [10' cord] & VS341)	0.38	0.17	
VEN91104	7/8" Nylon Swivel Pulley	0.05	0.02	
VS341	1/8" Cord Adjustment Strap *	0.01	0.01	

One (1) Support Drop Kit is required for each Support Drop needed.

* Conduit Supported pipe orders without winching will require one (1) VS341 per drop

5. Winching Cable (11.1 feet per Pipe Assembly)

Part Number	Description	Ship Weight		List Price
		LBS.	KG.	
VC343	Cable, 1/8" 7x7 Galvanized Aircraft Wire Rope	0.03	0.01	
VC343-Q1000	Cable, 1/8" 7x7 Galvanized Aircraft Wire Rope - 1000' Roll	25.00	11.34	

6. Drinker Selection

Part Number	Description	Quantity	Notes	Ship Weight		List Price
				LBS.	KG.	
VR150	Roaster Drinker	1		0.02	0.01	
VR150-QE100		100		2.45	1.11	
VR150-QE500		500		12.25	5.56	
VR150L	Roaster Drinker Low Flow	1		0.02	0.01	
VR150L-Q500		500		12.25	5.56	
VR150H	Roaster Drinker High Flow	1	VS156 Cup Optional	0.02	0.01	
VR150H-QE100		100		2.45	1.11	
VR150H-QE500		500		12.25	5.56	
VR150HX	Roaster Drinker Extra High Flow	1	VS156 Cup Optional	0.02	0.01	
VR150HX-QE100		100		2.45	1.11	
VR150HX-QE500		500		12.25	5.56	
VR150LPFA	Roaster Drinker E-Z Trigger, Low Flow	1		0.02	0.01	
VR150LPFA-QE100		100		2.45	1.11	
VR150LPFA-QE500		500		12.25	5.56	
VR150PFA	Roaster Drinker E-Z Trigger	1		0.02	0.01	
VR150PFA-QE100		100		2.45	1.11	
VR150PFA-QE500		500		12.25	5.56	
VR150HPFA	Roaster Drinker High Flow, E-Z Trigger	1	VS156 Cup Optional	0.02	0.01	
VR150HPFA-QE100		100		2.45	1.11	
VR150HPFA-QE500		500		12.25	5.56	
VR150HXPFA	Roaster Drinker Extra High Flow, E-Z Trigger	1	VS156 Cup Optional	0.02	0.01	
VR150HXPFA-QE100		100		2.45	1.11	
VR150HXPFA-QE500		500		12.25	5.56	
VBL150	Layer Drinker	1		0.02	0.01	
VBL150-QE100		100		2.45	1.11	
VBL150-QE500		500		12.25	5.56	
VQ150HPFA	Quencher Drinker	1		0.02	0.01	
VQ150HPFA-QE100		100		2.45	1.11	
VQ150HPFA-QE500		500		12.25	5.56	
VQ150MPFA	Quencher High Flow	1	VS156 Cup Optional	0.02	0.01	
VQ150MPFA-QE100		100		2.45	1.11	
VQ150MPFA-QE500		500		12.25	5.56	
VBR250	Breeder Drinker	1	VBS100 Shield or VC150 Clip Optional	0.02	0.01	
VBR250-QE100		100		2.45	1.11	
VBR250-QE500		500		12.25	5.56	
VBR250L	Breeder Drinker Low Flow	1	VBS100 Shield or VC150 Clip Optional	0.02	0.01	
VBR250L-QE100		100		2.45	1.11	
VBR250L-QE500		500		12.25	5.56	
VA150	Aqua-V Drinker	1		0.02	0.01	
VA150-QE100		100		2.45	1.11	
VA150-QE500		500		12.25	5.56	
VA150H	Aqua-V Drinker High Flow	1		0.02	0.01	
VA150H-QE100		100		2.45	1.11	
VA150H-QE500		500		12.25	5.56	
VA150PFA	Aqua-V Drinker PFA EZ-Trigger	1		0.02	0.01	
VA150PFA-QE100		100		2.45	1.11	
VA150PFA-QE500		500		12.25	5.56	
VA150LPFA	Aqua-V Drinker Low Flow PFA EZ-Trigger	1		0.02	0.01	
VA150HPFA	Aqua-V Drinker High Flow PFA EZ-Trigger	1		0.02	0.01	
VA150HPFA-QE100		100		2.45	1.11	
VA150HPFA-QE500		500		12.25	5.56	
VR150PFAZS	Roaster Drinker, PFA w/Ziggity Short Plug	1		0.02	0.01	

Minimum order of 2000 Drinkers. Use -QE numbers for order quantities less than 2000 Drinkers

7. Recommended Watering Accessories (Optional)

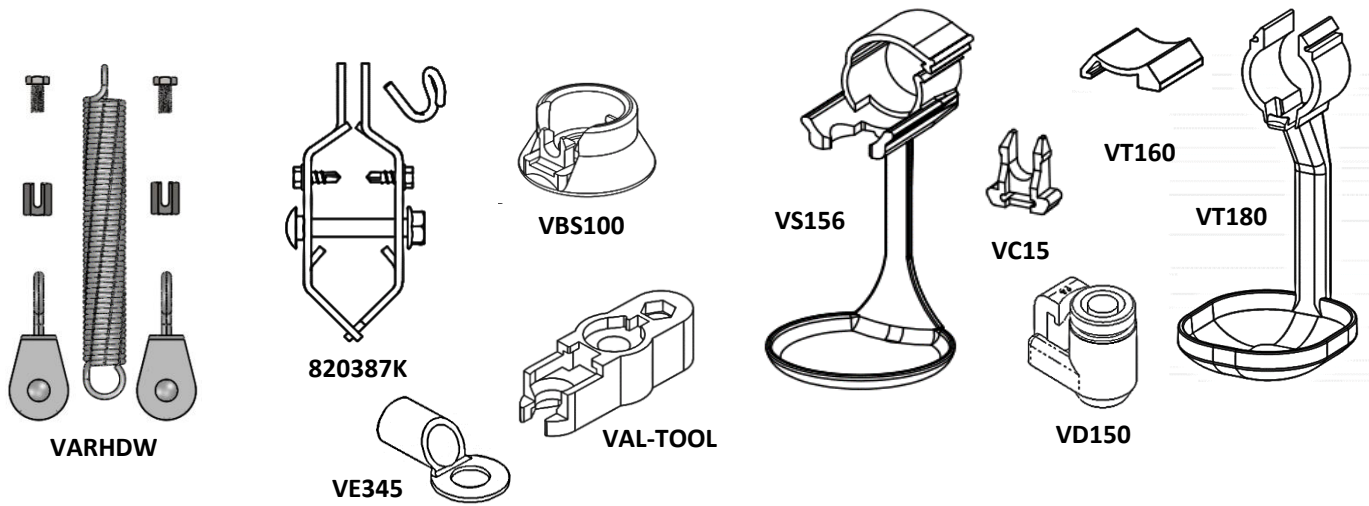









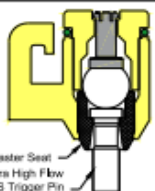
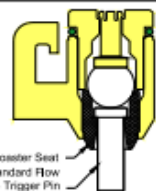

Part Number	Description	Ship Weight		List Price
		LBS.	KG.	
VARHDW	Anti-Roost Hardware Bag for Conduit & Aluminum 1 per Line	0.30	0.14	
VG342	Cable, 1/16, 1x7 Galvanized Aircraft Wire (Anti-Roost) - per Foot	0.01	0.00	
VG342-Q1000	Cable, 1/16, 1x7 Galvanized Aircraft Wire (Anti-Roost) - 1000' Roll	20.70	9.39	
VD319	Cord, 1/8" Natural Solid Braid Polyester	0.00	0.00	
VD319-Q1000	Cord, 1/8" Natural Solid Braid Polyester - 1000' Roll	7.00	3.18	
VE345	1/8" Wire Cable Closed Sta-kon	0.03	0.01	
VBS100	Breeder Shield	0.02	0.01	
VC150	Drinker Drinker Clip (Recommended for Heavy Breeders 1 per Drinker)	0.00	0.00	
820387K	Anti-Rotational Galvanized Holding Clamp Bracket Kit	0.29	0.13	
VS156	Cup for Aluminum Extrusion or Conduit	0.05	0.02	
VT160	Cup Clip, Used for Conduit Suspension	0.01	0.00	
VT180	New Cup for Aluminum Extrusion or Conduit (conduit requires VT160)	0.06	0.03	
VD150	Dummy Drinker	0.01	0.00	
VAL-TOOL	Universal Drinker Tool	0.03	0.01	
VAL-LOTT-STICK	Val Lott Stick for Measuring Drinker Water Flow Rate	1.50	0.68	
820624	Viewport - 3/4" Clear PVC with VC145 Coupler	0.12	0.05	

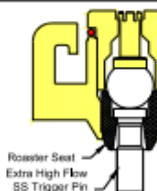
DRINKER INFO

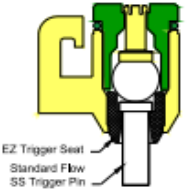
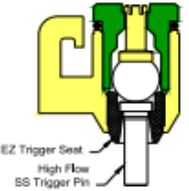
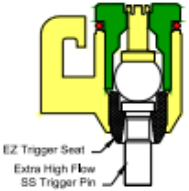
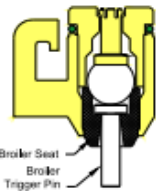
(SEE DESCRIPTIVE DRAWINGS OF EACH DRINKER ON PAGE 22-13)

CATALOG NUMBER	DESCRIPTION
VR150	ROASTER DRINKER The standard for broilers and larger birds. Bigger trigger pin resists wear and holds 300% more water than the Broiler Drinker.
VR150L	ROASTER DRINKER Roaster Drinker with lower water flow.
VR150H	ROASTER HI-FLOW DRINKER Same features as Roaster Drinker with higher flow for warmer temperatures.
VR150HX	ROASTER XTRA HI-FLOW DRINKER Roaster Drinker with higher flow for even warmer temperatures.
VR150LPFA	ROASTER CONTROLLED FLOW DRINKER WITH PRECISION FEATHER ACTION Roaster controlled flow drinker with feather side action where the slightest touch will produce water flow.
VR150PFA	ROASTER DRINKER WITH PRECISION FEATHER ACTION Roaster drinker with feather side action where the slightest touch will produce water flow.
VR150HPFA	ROASTER HI-FLOW DRINKER WITH PRECISION FEATHER ACTION Roaster Hi-Flow drinker with feather side action where the slightest touch will produce water flow.
VR150HXPFA	ROASTER XTRA HI-FLOW DRINKER WITH PRECISION FEATHER ACTION Roaster Xtra Hi-Flow drinker with feather side action where the slightest touch will produce water flow.
VBL150	LAYER DRINKER Drinker for small layers.
VA150	LAYER / BROILER DRINKER Drinker for layers and smaller birds.
VA150H	LAYER / BROILER DRINKER Hi-Flow Drinker for layers and smaller broilers.
VA150PFA	LAYER / BROILER DRINKER WITH PRECISION FEATHER ACTION Drinker for layers and smaller birds with feather side action where the slightest touch will produce water flow.
VA150LPFA	LAYER / BROILER DRINKER WITH PRECISION FEATHER ACTION Low-Flow Drinker for layers and smaller birds with feather side action where the slightest touch will produce water flow.
VA150HPFA	LAYER / BROILER DRINKER WITH PRECISION FEATHER ACTION Hi-Flow Drinker for layers and smaller broilers with feather side action where the slightest touch will produce water flow.
VQ150HPFA	QUENCHER DRINKER Standard flow, industry standard drinker.
VQ150MPFA	QUENCHER DRINKER High flow, industry standard drinker.
VBR250	BREEDER DRINKER Drinker built to use with breeders with up action only
VBR250L	BREEDER CONTROLLED FLOW DRINKER Drinker built to use with breeders with up action only

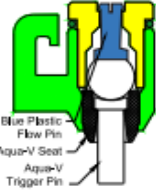
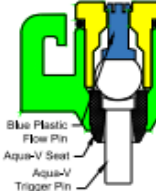
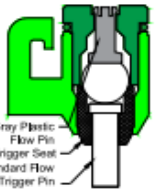
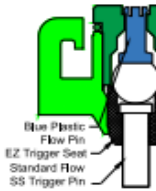
DRINKER INFO

	Controlled Flow Green O-Ring (VO140G)	Standard Flow Green O-Ring (VO140G)	High Flow Black O-Ring (VO140B)	Extra High Flow Red O-Ring (VO140R)
Premium Roaster	 <p>Roaster Seat Extra High Flow SS Trigger Pin</p> <p>VR150L Roaster, Controlled Flow</p>	 <p>Roaster Seat Standard Flow SS Trigger Pin</p> <p>VR150 Roaster, Standard Flow</p>	 <p>Roaster Seat High Flow SS Trigger Pin</p> <p>VR150H Roaster, High Flow</p>	 <p>Roaster Seat Extra High Flow SS Trigger Pin</p> <p>VR150HX Roaster, Extra High Flow</p>
Premium Precision Feather Action	 <p>Gray Plastic Flow Pin EZ Trigger Seat Extra High Flow SS Trigger Pin</p> <p>VR150LPFA EZ Trigger Roaster, Controlled Flow</p>	 <p>EZ Trigger Seat Standard Flow SS Trigger Pin</p> <p>VR150PFA EZ Trigger Roaster, Standard Flow</p>	 <p>EZ Trigger Seat High Flow SS Trigger Pin</p> <p>VR150HPFA EZ Trigger Roaster, High Flow</p>	 <p>EZ Trigger Seat Extra High Flow SS Trigger Pin</p> <p>VR150HXPFA EZ Trigger Roaster, Extra High Flow</p>
Layer Drinker		 <p>Broiler Seat Broiler Trigger Pin</p> <p>VBL150 Layer Drinker, Standard Flow</p>		
Quencher Precision Feather Action			 <p>Gray Plastic Flow Pin Quencher Seat Quencher Trigger Pin</p> <p>VQ150HPFA Quencher Drinker, High Flow</p>	 <p>Blue Plastic Flow Pin Quencher Seat Quencher Trigger Pin</p> <p>VQ150MPFA Quencher Drinker, Extra High Flow</p>
Breeder Drinker	 <p>Gray Plastic Flow Pin Breeder Seat Standard Flow SS Trigger Pin</p> <p>VBR250L Breeder Drinker, Controlled Flow</p>	 <p>Blue Plastic Flow Pin Breeder Seat Standard Flow SS Trigger Pin</p> <p>VBR250 Breeder Drinker, Standard Flow</p>		
Aqua-V		 <p>Blue Plastic Flow Pin Aqua-V Seat Aqua-V Trigger Pin</p> <p>VA150 Aqua-V Drinker, Standard Flow</p>	 <p>Blue Plastic Flow Pin Aqua-V Seat Aqua-V Trigger Pin</p> <p>VA150H Aqua-V Drinker, High Flow</p>	
Aqua-V Precision Feather Action	 <p>Gray Plastic Flow Pin EZ Trigger Seat Standard Flow SS Trigger Pin</p> <p>VA150LPFA EZ Trigger Aqua-V Drinker, Controlled Flow</p>	 <p>Blue Plastic Flow Pin EZ Trigger Seat Standard Flow SS Trigger Pin</p> <p>VA150PFA EZ Trigger Aqua-V Drinker, Standard Flow</p>	 <p>Blue Plastic Flow Pin EZ Trigger Seat High Flow SS Trigger Pin</p> <p>VA150HPFA EZ Trigger Aqua-V Drinker, High Flow</p>	

DRINKER FLOW RATES

Roaster Series Flow Rates vs. Inches [Centimeters] of Water

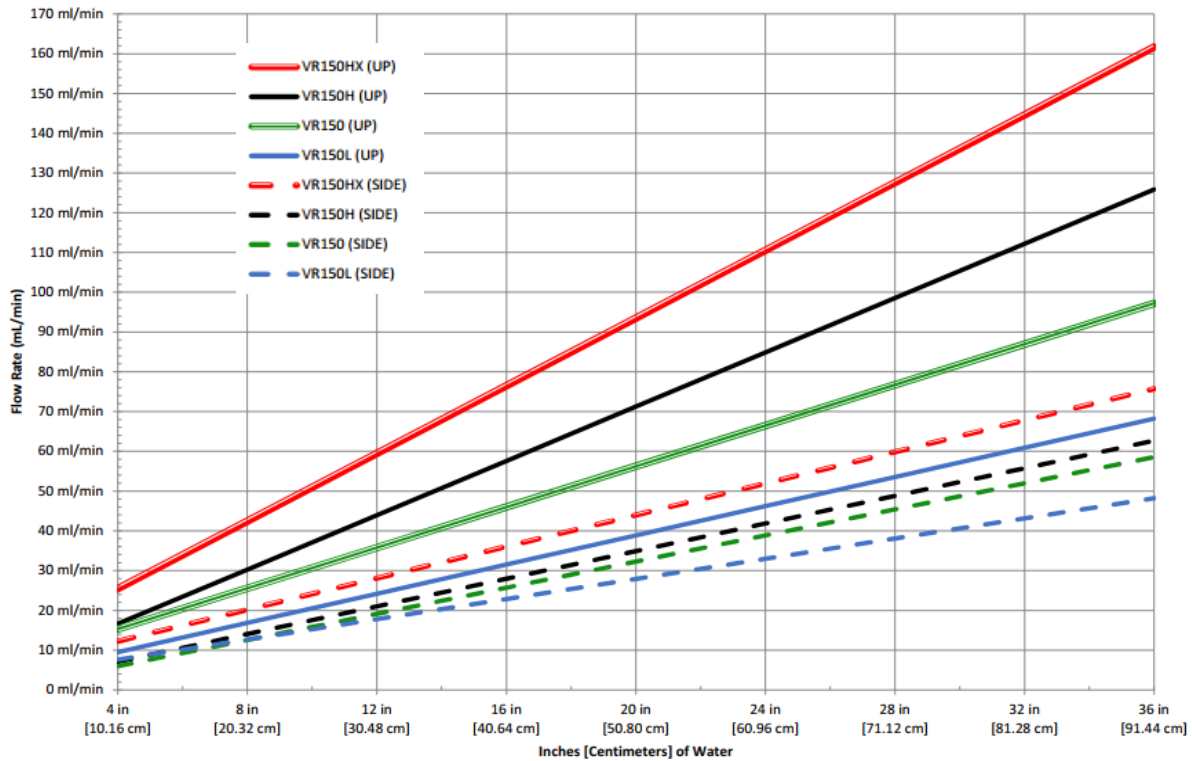

Roaster PFA Flow Rates vs. Inches [Centimeters] of Water

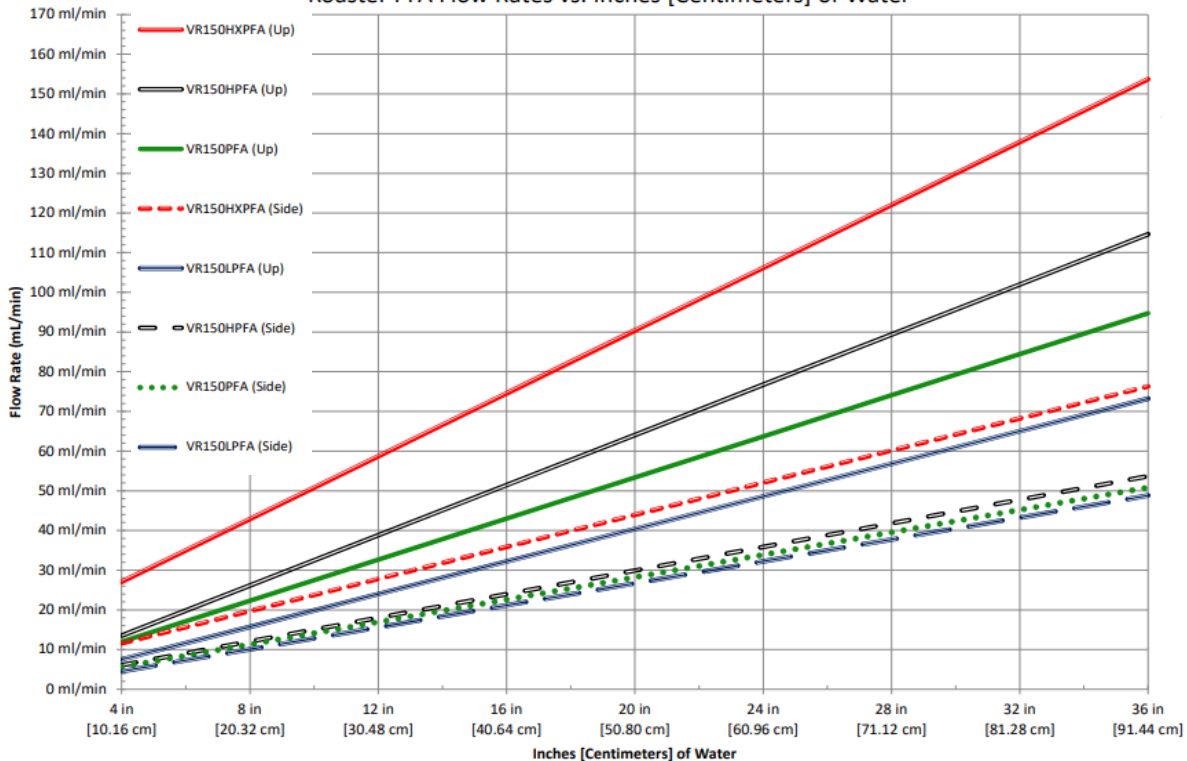

If a drinker produces more water than a bird can consume it causes wet floors. A higher flow rate can be generated with a taller standpipe. This will ensure the necessary water volume at growout. As natural wear occurs in the drinker, there will be room to back off pressure to prolong the life of the drinker.

DRINKER FLOW RATES

Broiler / Layer Drinker Flow Rates vs. Inches [Centimeters] of Water

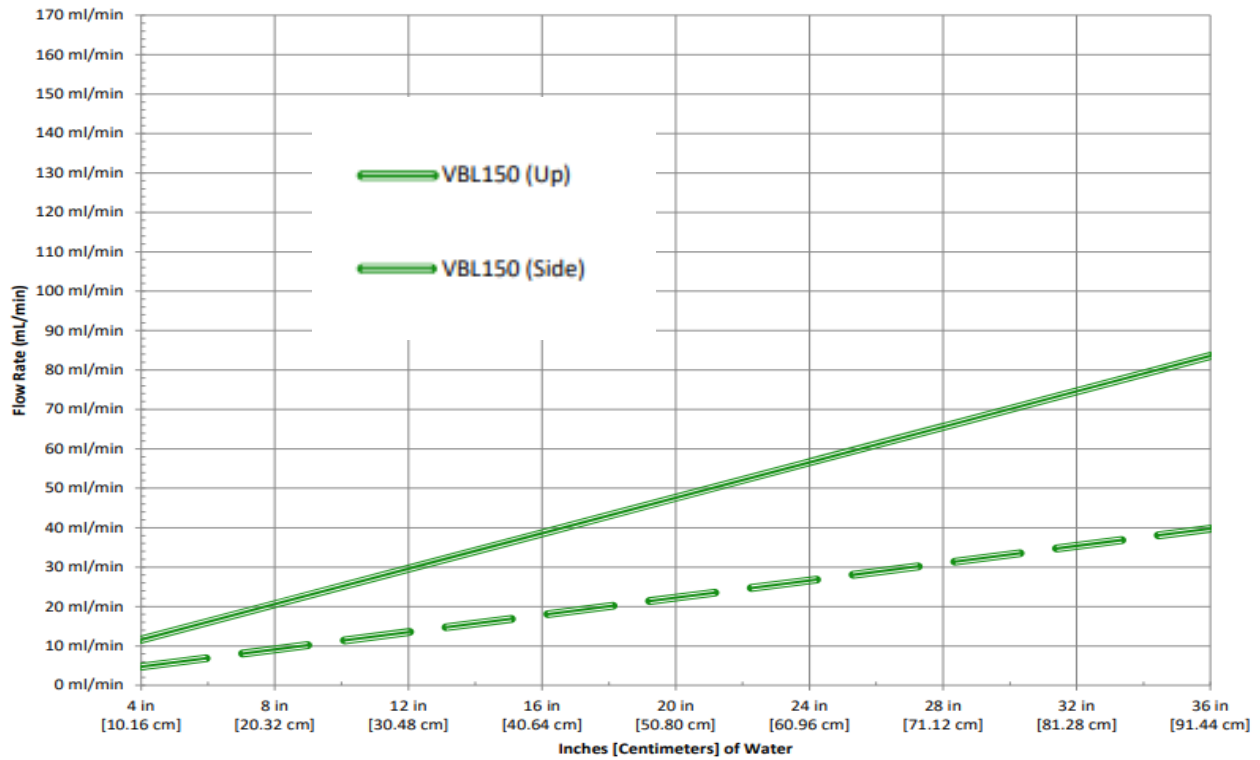

Breeder Drinker Flow Rates vs. Inches [Centimeters] of Water

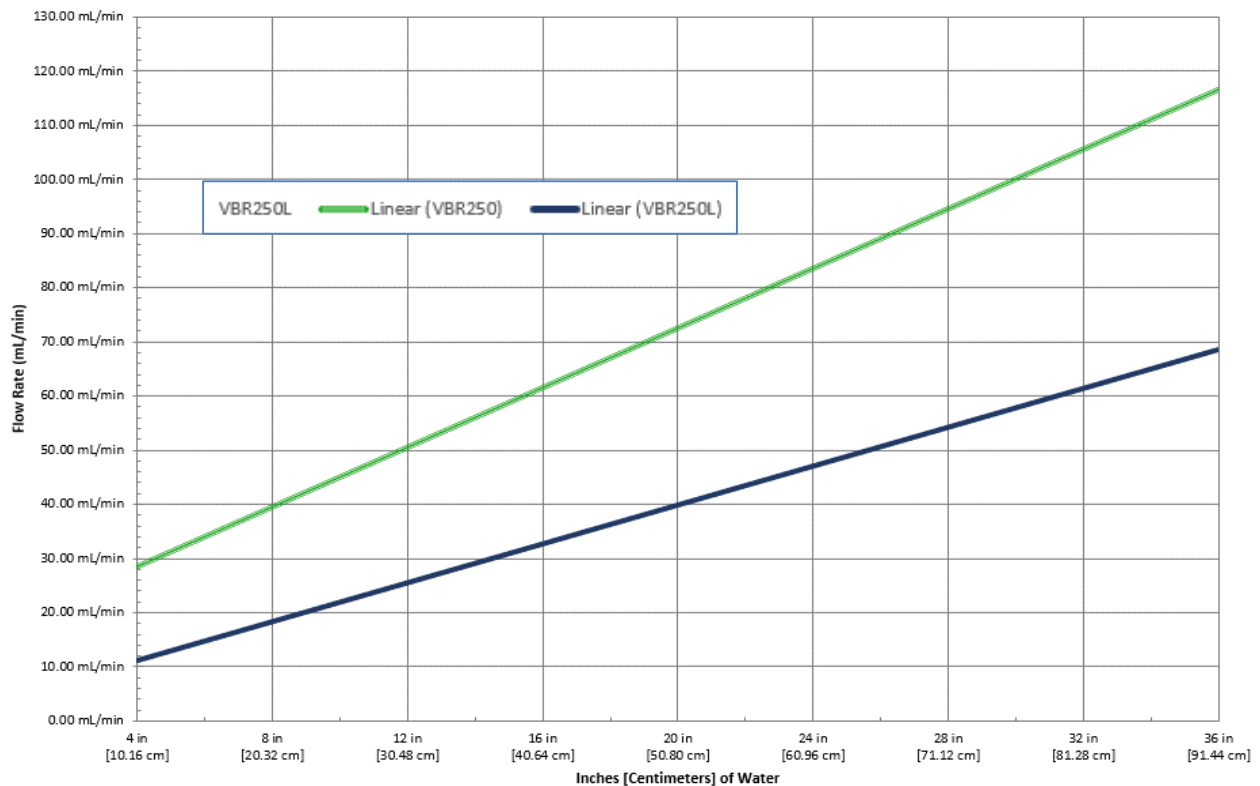

If a drinker produces more water than a bird can consume it causes wet floors. A higher flow rate can be generated with a taller standpipe. This will ensure the necessary water volume at growout. As natural wear occurs in the drinker, there will be room to back off pressure to prolong the life of the drinker.

DRINKER FLOW RATES

Aqua-V PFA Series Flow Rates vs. Inches [Centimeters] of Water

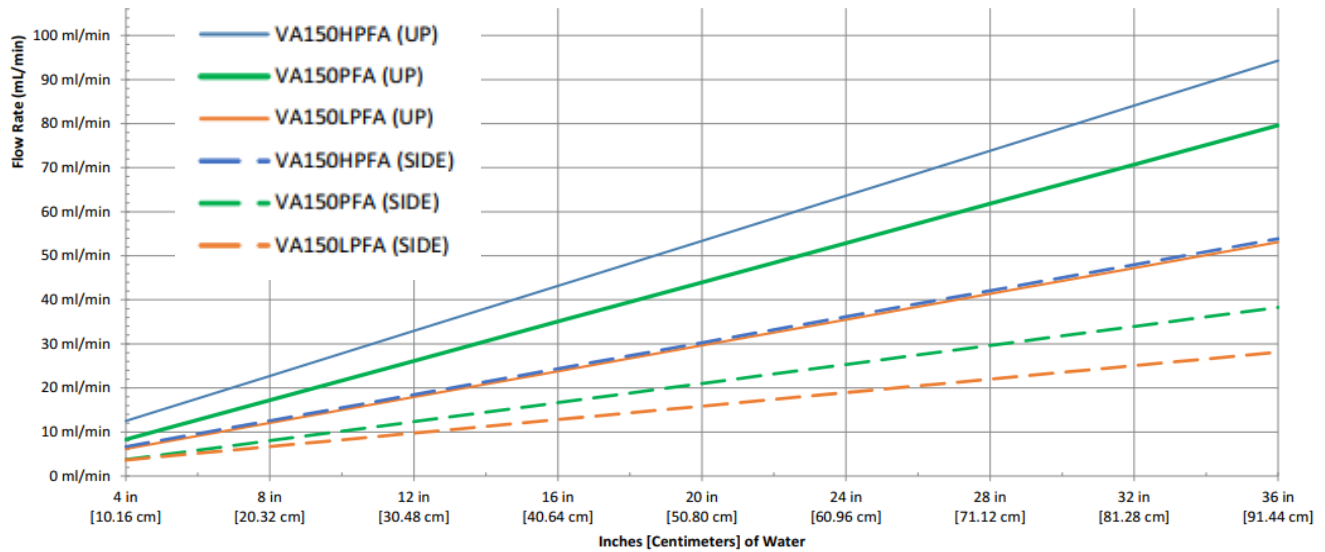

If a drinker produces more water than a bird can consume it causes wet floors. A higher flow rate can be generated with a taller standpipe. This will ensure the necessary water volume at growout. As natural wear occurs in the drinker, there will be room to back off pressure to prolong the life of the drinker.

DRINKER FLOW RATES

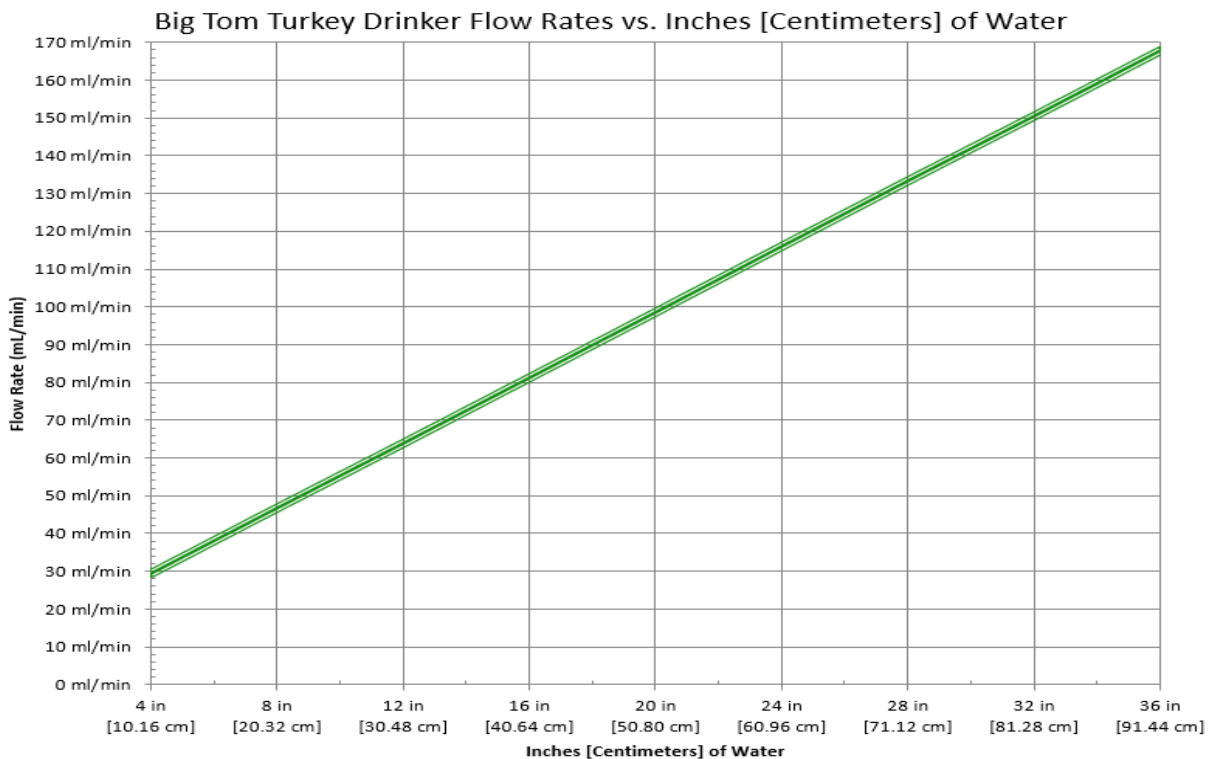
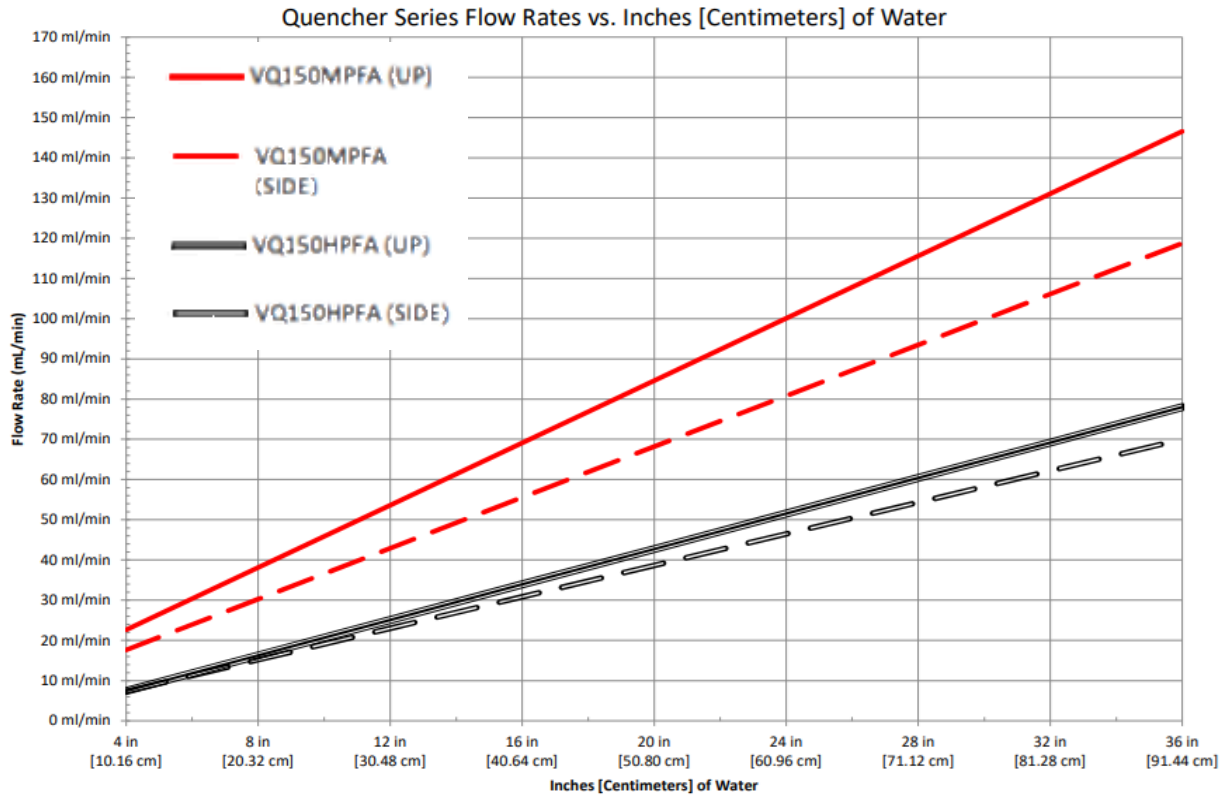

If a drinker produces more water than a bird can consume it causes wet floors. A higher flow rate can be generated with a taller standpipe. This will ensure the necessary water volume at growout. As natural wear occurs in the drinker, there will be room to back off pressure to prolong the life of the drinker.

FLOOR WATERING OPTIONS

COMPETITOR CHANGEOVER & REPLACEMENT ITEMS

Order Drinkers Separately

CATALOG #	ITEM DESCRIPTION	SHIP WEIGHT		LIST PRICE
		LBS.	KG.	
VA505	Pipe Clip Val Chore-Time Hanger Clip for CTB Aluminum <i>Note: The drinker pipe must be replaced with new Val pipe, but the existing suspension and winching for the line can be used. Refer to page 22-08 for the Chore-Time replacement pipe kit.</i>	0.01	0.00	
VCTB110-K	Chore-Time Saddle Adapter Kit	0.01	0.00	
820104	LUBING ADAPTER KIT Works for 22mm square pipe systems EXCLUDING OPTI-GROW <i>Note: This kit does not work as an adaptor for Optigrow drinkers due to the larger diameter hole/drinker body of the Optigrow</i>	0.02	0.01	
VP500RK	Val Plasson Saddle Kit <i>Note: This is a direct replacement for the Plasson drinker - includes saddle and seal. There is no need to replace pipe or suspension & winching hardware.</i>	0.03	0.01	
VP556	Val Plasson Saddle Tool for applying saddle adapter	0.26	0.12	
VPG555RK	Val Plasson Adapter Seal <i>Note: Replacement seal for Val Plasson Saddle Kit.</i>	0.00	0.00	
VZA150	Val Ziggity Saddle Kit <i>Note: This kit includes a replacement adapter (with new O-ring) to replace the Ziggity twin style drinker. This adapter will accept any Val standard J-lock drinker. This retro-fit saddle locks into the Ziggity twin lock saddle, then the Val J-lock can be installed into the adapter. With this kit there is no need to replace the pipe or suspension/winching hardware.</i>	0.01	0.00	
VZA150-Q50	Val Ziggity Saddle Kit - Quantity of 50	0.40	0.18	
820056	Val Ziggity Adapter Seal <i>Note: Replacement seal for Val Ziggity Saddle Kit</i>	0.00	0.00	
820258	Val Cumberland Saddle Kit	0.01	0.00	
820258-Q50	Val Cumberland Saddle Kit - Quantity of 50	0.40	0.18	
820188	Val Cumberland Adapter Seal <i>Note: Replacement seal for Val Cumberland Saddle Kit</i>	0.00	0.00	
VH341	Ribbed Hanger Bracket for 3/4" Galvanized Pipe (1.05" OD) With Nut & Bolt	0.03	0.02	
VR150C	Roaster Drinker for Clark	0.02	0.01	
VR150THD-QE500	Roaster Drinker - Threaded (Quantity of 500)	12.25	5.56	
VR150THD-QE100	Roaster Drinker - Threaded (Quantity of 100)	2.45	1.11	
VR150THD	Roaster Drinker - Threaded	0.02	0.01	
VL150THD-QE500	Layer Drinker - Threaded (Quantity of 500)	12.25	5.56	
VL150THD-QE100	Layer Drinker - Threaded (Quantity of 100)	2.45	1.11	
VL150THD	Layer Drinker - Threaded <i>Note: These drinkers are a replacement for Lubing (excluding Optigrow) or any similar European style threaded drinker. The internal components of these drinkers are the same as a standard Val Drinker. An advantage of these drinkers is that after the drinker has been threaded into the pipe the internal components can be removed from the drinker without removing the unit from the pipe. These drinkers can be ordered as a Roaster, Broiler, or Layer as indicated above.</i>	0.02	0.01	
VS205	Glued Saddle for Small Square Pipe - For Threaded Drinker - 1/4" (6.35mm) Stem	0.01	0.01	
VS205L	Glued Saddle for Small Square Pipe - For Threaded Drinker - 11/32" (8.73mm) Stem	0.01	0.00	
VS405	Glued Saddle for Large Square Pipe - For Threaded Drinker - 1/4" (6.35mm) Stem	0.01	0.00	
VS405L	Glued Saddle for Large Square Pipe - For Threaded Drinker - 11/32" (8.73mm) Stem <i>Note: VS205L & VS405L are replacement saddle for square pipe that previously had threaded drinkers; the stem is slightly larger than the standard glued saddle so it can be glued into the existing threaded hole.</i>	0.01	0.00	

Minimum order of 2000 Drinkers. Use -QE part numbers for quantities less than 2000 Drinkers

TURKEY BELL DRINKERS

TURKEY BELL DRINKERS		SHIP WEIGHT		LIST PRICE
		LBS.	KG.	
VTB105	Turkey Bell Drinker Kit - without Flange <i>(Includes Tubing, Valve Assembly, Clip and Strap)</i>	2.39	1.1	
VTB135	Turkey Bell Drinker - without Flange - Base Assembly	2.27	1.0	
VTB100	Turkey Bell Drinker Kit - with Flange <i>(Includes Tubing, Valve Assembly, Clip and Strap)</i>	3.00	1.4	
VTB130	Turkey Bell Drinker - with Flange - Base Assembly	2.60	1.2	

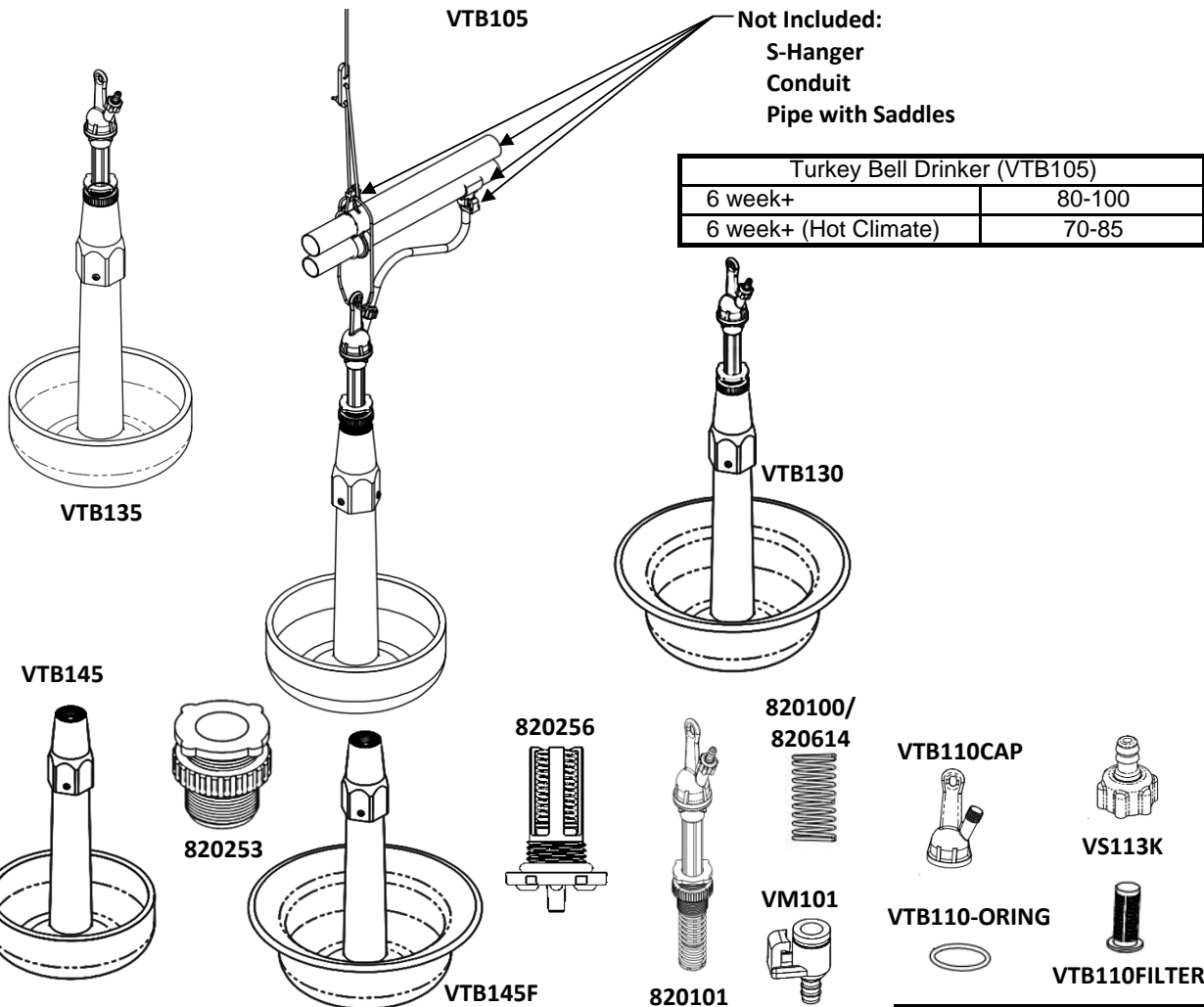

Repair Parts

Repair Parts		SHIP WEIGHT		LIST PRICE
		LBS.	KG.	
VTB145	Turkey Bell Drinker - Bowl Assembly	1.37	0.6	
VTB145F	Turkey Bell Drinker with Flange - Bowl Assembly	2.10	1.0	
820101	Turkey Bell Drinker Valve Assembly - Stainless Steel Spring	0.23	0.1	
820256	Turkey Bell Drinker - Stianless Steel Trigger Pin Assembly	0.05	0.0	
820253	Turkey Bell Drinker - Adjustment Nut Assembly	0.04	0.0	
820100	Turkey Bell Drinker - Large Stainless Steel Spring	0.07	0.0	
VM101	Mini Drinker Adapter with Nipple Body	0.01	0.0	
VTB110CAP	Turkey Bell Valve - Cap without O-Ring	0.02	0.0	
VS113K	Male Barb Stud and Nut Assembly	0.00	0.0	
BG222	1/4" Green PVC Tubing (price per foot)	0.03	0.0	
VTB110-ORING	Turkey Bell Valve - O-ring (for inside VTB110CAP)	0.01	0.0	
VTB110FILTER	Turkey Bell Valve - Stem Filter	0.00	0.0	

VAL-CO FLOOR WATERING PIPE KITS - TURKEY

DETERMINE CATALOG NUMBER FOR PRICE LOOKUP

SELECTIONS
 REQUIRED TO MAKE A
 COMPLETE PIPE KIT
 CATALOG NUMBER →

EXAMPLE OF COMPLETE
 PIPE KIT CATALOG NO. →

1 KIT TYPE	2 SUPPORT & WINCHING	3 Drinker TYPE	4 DROP SPACING	5 PIPE TYPE
VBT05	3	L	0	0

NOTE
SELECT 9 DIGIT PIPE KIT CATALOG NUMBER -
SEE PRICING ON PAGES 22-21

1 SELECT KIT TYPE

VBT KITS = Pipe kits with Big Tom Cup System from Start to Finish (Select Big Tom drinker L only)

SELECT VBT KIT WITH NUMBER OF DRINKERS NEEDED

VBT KITS	NUMBER OF Drinker DRINKERS	DRINKER SPACING	
		IN	CM
VBT05	5	24.0	61.0
VBT06	6	20.0	50.8
VBT07	7	17.1	43.5
VBT08	8	15.0	38.1
VBT09	9	13.3	33.9
VBT10	10	12.0	30.5
VBT11	11	10.9	27.7
VBT12	12	10.0	25.4
VBT13	13	9.2	23.4
VBT14	14	8.3	21.8
VBT15	15	8.0	20.3

2 SELECT SUPPORT & WINCHING

SELECT	SUPPORT TYPE	WINCHING	COMPONENTS INCLUDED
3	With Conduit VH340 Hanger	With Winching	A-L
4	With Conduit VH340 Hanger	Without Winching	A-B, J-L
5	Without Conduit VH340 Hanger	Without Winching	A-B, J
6	With Aluminum VH340AL Hanger	With Winching	A-I, M-P
7	With Aluminum VH340AL Hanger	Without Winching	A-B, M-P
8	W/O Aluminum VH340AL Hanger	Without Winching	A-B, P

- ▶ If selecting "3" or "6", order 1 - VARHWDW Kit per LINE (not per 10' pipe section).
- ▶ If selecting "6" or "7", order 1 - VBTHDVAL Kit per LINE (not per 10' pipe section).
- ▶ See hanger descriptions on page 9

PIPE KIT COMPONENTS LISTING

KEY	CAT #	ITEM DESCRIPTION (QTY PER KIT)
A	VKPXX	10' PVC Pipe With Coupler & With Saddles (1)
B	VS341	Height Adjustment Strap (1)
C	VG342	1/16" Anti-Roost Wire (10')
F	VC343	1/8" Winching Cable (11.1')
G	VE345	Drop Cord Clamp (1)
H	VD319	1/8" Drop Cord (10')
I	VEN91104	7/8" Nylon Swivel Pulley (1)
J	VH340	Bolted Hanger Bracket (5 min.)
K	VC318	10' x 1" Conduit (1)
L	VC317	1" Conduit Coupler (1)
M	VA318	10' Aluminum Extrusion (1)
N	VA317	8" Aluminum Extrusion Connector (1)
O	VA319	Hex Head Self-Drilling Screw (2)
P	VH340AL	Bolted Hanger Bracket for Aluminum Extrusion (5 min.)

- ▶ VP321 J Nail is no longer included - must be ordered separately from catalog section 19.

VAL-CO WATERING FLOOR KITS
 DETERMINE CATALOG NUMBER FOR PRICE LOOKUP (CONTINUED)

3 CONTENTS		
SELECTION	Drinker DRINKER TYPE	Drinker DRINKER CATALOG NUMBER
L	Big Tom Cup System	VBT185L
OPTIONAL TURKEY STARTER FLOAT BALL		
Order 1 - VT185L-FB Turkey Starter Float Ball per Big Tom Drinker Cup - list price is \$ each.		

TURKEY DRINKER DESCRIPTIONS
VBT185L - Perfect drinker & cup combo for birds from start to finish. Great alternative to bell drinkers.

4 SELECT DROP SPACING		
SELECT	DROP SPACING	
0	Kit With 10 ft. Drops	
8	Kit With 8 ft. Drops	

Note: 8' drop spacing option is available only if ordering pipe kit with winching.

5 SELECT PIPE TYPE		
SELECT	PIPE TYPE	
0	Kit With Standard Pipe (VP001 With VS180 Saddles)	
NOTE: <i>Insulated Pipe is No Longer Available</i>		

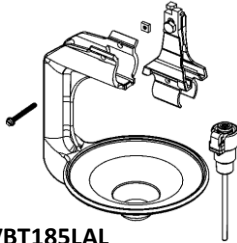
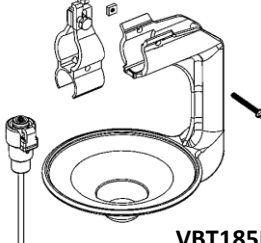
 <p>VBT185LAL</p>	RECOMMENDED DENSITY PER Drinker BIG TOM CUP SYSTEM (VBT185L)	 <p>VBT185L</p>															
	<table border="1"> <thead> <tr> <th>Type</th> <th>Birds/Cup</th> <th>Max Cups/Pipe</th> </tr> </thead> <tbody> <tr> <td>Poult</td> <td>30-40</td> <td>8</td> </tr> <tr> <td>Hen Finish</td> <td>25-30</td> <td>5</td> </tr> <tr> <td>Tom Finish</td> <td>20-25</td> <td>5</td> </tr> <tr> <td>Tom Heavy Finish</td> <td>Max 20</td> <td>5</td> </tr> </tbody> </table>	Type	Birds/Cup	Max Cups/Pipe	Poult	30-40	8	Hen Finish	25-30	5	Tom Finish	20-25	5	Tom Heavy Finish	Max 20	5	
Type	Birds/Cup	Max Cups/Pipe															
Poult	30-40	8															
Hen Finish	25-30	5															
Tom Finish	20-25	5															
Tom Heavy Finish	Max 20	5															

PIPE KIT #	LIST \$	PIPE KIT #	LIST \$	PIPE KIT #	LIST \$	PIPE KIT #	LIST \$	PIPE KIT #	LIST \$
VBT043L80		VBT067L00		VBT093L00		VBT117L00		VBT143L00	
VBT044L00		VBT068L00		VBT093L80		VBT118L00		VBT143L80	
VBT046L80		VBT073L00		VBT094L00		VBT123L00		VBT144L00	
VBT047L00		VBT073L80		VBT095L00		VBT123L80		VBT145L00	
VBT053L00		VBT074L00		VBT096L00		VBT124L00		VBT146L00	
VBT053L80		VBT075L00		VBT096L80		VBT125L00		VBT146L80	
VBT054L00		VBT076L00		VBT097L00		VBT126L00		VBT147L00	
VBT055L00		VBT076L80		VBT098L00		VBT126L80		VBT148L00	
VBT056L00		VBT077L00		VBT103L00		VBT127L00		VBT153L00	
VBT056L80		VBT078L00		VBT103L80		VBT128L00		VBT153L80	
VBT057L00		VBT083L00		VBT104L00		VBT133L00		VBT154L00	
VBT058L00		VBT083L80		VBT108L00		VBT133L80		VBT155L00	
VBT063L00		VBT084L00		VBT113L00		VBT134L00		VBT156L00	
VBT063L80		VBT085L00		VBT113L80		VBT135L00		VBT156L80	
VBT064L00		VBT086L00		VBT114L00		VBT136L00		VBT157L00	
VBT065L00		VBT086L80		VBT115L00		VBT136L80		VBT158L00	
VBT066L00		VBT087L00		VBT116L00		VBT137L00			
VBT066L80		VBT088L00		VBT116L80		VBT138L00			

FLOOR WATERING OPTIONS

Turkey Drinker

CATALOG #	ITEM DESCRIPTION	SHIP WEIGHT		LIST PRICE
		LBS.	KG.	
VT185L-FB	Big Tom Starter Float Ball	0.02	0.01	
VT150XLP	Turkey Drinker - With Long Pin for Big Tom	0.02	0.01	
VBT185L	Big Tom Cup & Drinker Kit (Universal Saddle Only)	0.52	0.23	

Mini Drinkers

VM100	Trough Mini Drinker with Adapter - for Conduit	80-100 Chicks	1.07	0.49	
VM200	Trough Mini Drinker with Adapter - for Aluminum Ext.	50-70 Ducklings	2.34	1.06	
VM101	Mini Drinker Adapter W/ Drinker Body		0.01	0.00	
VM102	Valve Assy W/ Bumper		0.02	0.01	
VM103	Float		0.02	0.01	
VM104	Triple Hanger Bracket For Mini Drinker		0.12	0.05	
VM105	Cover Plate For Mini Drinker		0.04	0.02	
VM106	Trough For Mini Drinker		0.68	0.31	
VM107	Bumper For Mini Drinker		0.03	0.01	
VM111	Single Hanger Bracket For Aluminum Suspension		0.08	0.04	

TruSeal™ Replacement Standpipe Caps

820295	Direct replacement standpipe cap for Flexible standpipes		0.05	0.02	
820611	Direct replacement standpipe cap for Rigid standpipes		0.06	0.03	
820348	TruSeal rigid standpipe kit. Includes cap and float ball		0.06	0.03	
820349	TruSeal flex standpipe kit. Includes cap and float ball		0.06	0.03	
VC025TS	TruSeal flex cap kit includes cap and glue on adapter		0.06	0.03	
VS130	Spring for 18" flex standpipe when using TruSeal Cap		0.17	0.07	
VS132	Spring for 24" flex standpipe when using TruSeal Cap		0.23	0.10	
VS133	Spring for 30" flex standpipe when using TruSeal Cap		0.28	0.13	
VS134	Spring for 36" flex standpipe when using TruSeal Cap		0.34	0.15	

Replacement Standpipes (for VSPxxRR after shutoff)

VSP12RA	RIGID SP ASSY, 12", 1/2" NPT		0.15	0.07	
VSP18RA	RIGID SP ASSY, 18", 1/2" NPT		0.19	0.09	
VSP24RA	RIGID SP ASSY, 24", 1/2" NPT		0.30	0.14	
VSP30RA	RIGID SP ASSY, 30", 1/2" NPT		0.27	0.12	
VSP36RA	RIGID SP ASSY, 36", 1/2" NPT		0.32	0.14	
VSP12RA-FC	RIGID SP ASSY, 12", 1/2" NPT with Flat Cap		0.00	0.00	
VSP18RA-FC	RIGID SP ASSY, 18", 1/2" NPT with Flat Cap		0.00	0.00	
VSP24RA-FC	RIGID SP ASSY, 24", 1/2" NPT with Flat Cap		0.00	0.00	
VSP30RA-FC	RIGID SP ASSY, 30", 1/2" NPT with Flat Cap		0.00	0.00	
VSP36RA-FC	RIGID SP ASSY, 36", 1/2" NPT with Flat Cap		0.00	0.00	

Replacement Standpipe

VSP24FY	FLEX SP ASSY, 24", Replacement [Flex Tube & TruSeal]		0.11	0.05	
---------	--	--	------	------	--

Miscellaneous

VE326	Garden Hose Adapter		0.03	0.01	
VE326M	Garden Hose Adapter - Metric		0.03	0.01	
VF204C	Hose Clamp For 3/8" Urethane (Use On The VF205)		0.01	0.01	
VF205	Clear Urethane Hose (Transparent Yellow)		0.06	0.03	

FLOOR WATERING OPTIONS

Conduit CATALOG #	ITEM DESCRIPTION	SHIP WEIGHT		LIST PRICE
		LBS.	KG.	
VC317	1" (1.163 OD) Metal Conduit Coupling Only	0.13	0.06	
VC318	1" (1.163 OD) 10' Thin Wall Conduit Only - No Coupling	4.20	1.91	
820347K	Anti-Rotational Bracket Kit Only	0.40	0.18	
820347K-Q30	Anti-Rotational Bracket Kit Only - Quantity of 30	10.99	4.98	
820522	S-Hook - Open x Closed with .45" useable length	0.01	0.00	
820422	1.163 OD Conduit Connector for VC318 Conduit	0.01	0.01	
820422C	1.163 OD Conduit Cap for VC318 Conduit	0.01	0.00	
VC345	Anti-Roost Clamp W/ 10-24X3/8 Hex head Screw	0.02	0.01	
VC346	Anti-Roost Spring	0.13	0.06	
VG342	1/16" Anti-Roost Wire	0.01	0.00	
820387K	Holding Clamp. Required every 10' for perching applications.	0.29	0.13	
820387K-Q25	Holding Clamp. Box of 25	8.11	3.68	
820479K	Holding Clamp Set with Anti-Tilt Hanger (Conduit and Aluminum Extrusion)	0.76	0.34	
820497K	Regulator Anti-Tilt Hanger Kit for Conduit (includes hardware)	0.33	0.15	
HB612E	Bolted Hanger Bracket for 1" (1.163" OD) Conduit No Hardware / No Clip	0.04	0.02	
VH340	Bolted Hanger Bracket for 1" (1.163" OD) Conduit With Hardware/No Clip	0.04	0.02	
VH341	Ribbed Bolted Hanger Bracket 3/4" (1.05" OD) Conduit with Hardware/No Clip	0.03	0.02	
VC340	Hanger Clip Only	0.01	0.00	
VN150	Nut For Hanger Bracket	0.01	0.00	
VN151	1/4" - 20 X 3/4" Bolt For Hanger Bracket Or 2 Per Winch	0.01	0.01	
VN152	Nut & Bolt For Hanger Bracket	0.03	0.01	
VH356	Clip only for VH355 S-Hanger Bracket	0.01	0.00	

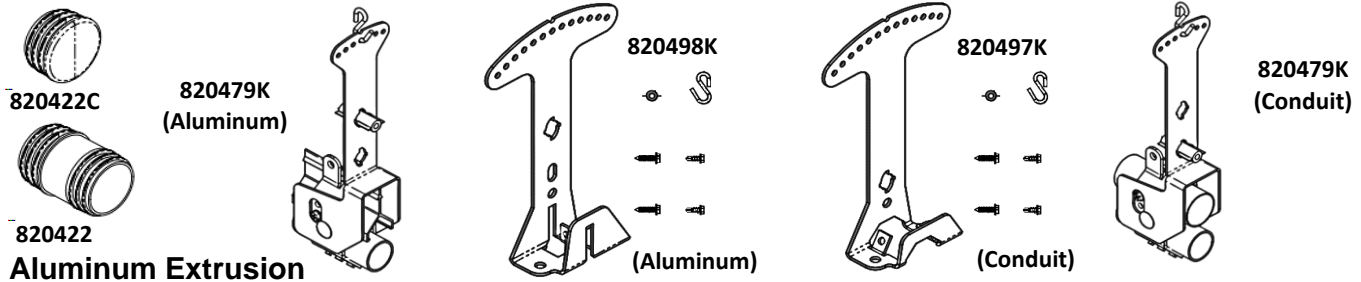

VA317	Aluminum Connector - 8" (PAT.)	0.07	0.03	
VA318	10' Aluminum Extrusion (PAT.)	2.30	1.04	
VA318-Q300	10' Aluminum Extrusion (PAT.) - Bundle of 300	654.00	296.65	
VA319	Hex head Self Drilling Screw 1/2" Length	0.00	0.00	
VA320	Hex head Screw Holder	0.00	0.00	
820498K	Regulator Anti-Tilt Hanger Kit for Aluminum Extrusion	0.33	0.15	
VA500	Pipe Clip (Attaches PVC Pipe To Aluminum)	0.01	0.00	
VA600	Hanger Clip 1" (Hangs Aluminum Extrusion)	0.01	0.00	
VA601	Hanger Clip 2" (Hangs Aluminum Extrusion)	0.03	0.01	

PVC Pipe & Valves

VP001	10' 3/4" Plain PVC Pipe	1.20	0.54	
VT194	1 1/2" PVC Pipe (10')	3.35	1.52	
VC100	PVC Pipe Cutter (1 1/4" Max Diameter)	1.05	0.48	
VC145	3/4" Coupler W/ O-Ring	0.05	0.02	
VO145	O-Ring For 3/4" Couplings	0.00	0.00	
730415	PVC Cement Glue (1/2 Pint)	1.00	0.45	
VG124	PVC Cement Glue (Pint)	1.14	0.52	
VG125	PVC Cement Glue (Quart)	2.14	0.97	
VC210	PVC Cleaner (1/2 Pint)	0.59	0.27	
VV801	3/4" Ball Valve	0.24	0.11	
VX127	3/4" Pipe Union	0.16	0.07	

FLOOR WATERING OPTIONS

PVC FITTINGS		SHIP WEIGHT		LIST PRICE
		LBS.	KG.	
CATALOG #	ITEM DESCRIPTION			
VC146	3/4" PVC Coupling SXS	0.30	0.14	
VC148	3/4" PVC Cross SXSXSXS	0.01	0.00	
VT100	3/4" PVC Tee SXSXS	0.01	0.00	
VT101	3/4" PVC Tee SXSX 1/2" Thread	0.94	0.43	
VT102	3/4" PVC 90 ELL SXS	0.08	0.04	
VT106	3/4" Female Slip X 1/2" FPT PVC Reducer	0.05	0.02	
VT107	3/4" Male Slip X 1/2" FPT Bushing	0.03	0.01	
VT130	3/4" PVC Tee SXSX Thread	0.01	0.00	
VT131	3/4" PVC Male Adapter SX Thread	0.04	0.02	
VT132	3/4" PVC Female Adapter SX Thread	0.05	0.02	
VT133	3/4" PVC 90 ELL SX Thread	0.04	0.02	
VT134	3/4" PVC 90 ELL SX 1/2" Thread	0.07	0.03	
VT135	3/4" PVC 90 Degree ELL SX 1/2" S	0.01	0.00	
VT141	1" PVC Male Adapter Thread X 3/4" S	0.01	0.00	
VT188	1/2" PVC Male Adapter 1/2" Slip X 1/2" Thread	0.03	0.02	
VT189	3/4" PVC Bushing SX 1/2" S Reducer	0.02	0.01	
VT190	1/2" PVC Tee SXSXS	0.00	0.00	
VT191	1/2" Coupling SXS	0.03	0.01	
VT192	1/2" PVC 90N ELL SXS	1.42	0.64	
VT195	1 1/2" X 3/4" Bushing SXS	0.12	0.05	
VT196	1 1/2" PVC Cross DWV Fitting	7.16	3.25	
VT197	1/2" Union SXS	0.01	0.00	
VT198	1 1/2" PVC Coupler	0.16	0.07	
VT199	1 1/2" PVC Tee	0.16	0.07	
VT200	1 1/2" 90 Degree PVC ELL	0.28	0.13	
VT201	3/4" X 3/4" X 1/2" Tee SXSXS	0.10	0.05	
VT202	Bushing 1-1/2" X 1/2" THD.	0.10	0.04	
VT203	Bushing 1-1/2" X 1/2" S	0.00	0.00	
VT204	Socket 1-1/2" X 1-1/2" Barbed	0.14	0.06	
VT205	3/4" PVC Plug - Threaded	0.03	0.01	
VC143	Square-to-Round Connector (small square pipe)	0.02	0.01	
VC243	Square-to-Round Connector (large square pipe)	0.02	0.01	
820270	Square-to-Square Flex Coupler assembly (1.1" square pipe)	0.07	0.03	
820271	Square-to-Square Flex Coupler assembly (.875" square pipe)	0.06	0.03	

VR-202 V-MAX REGULATOR

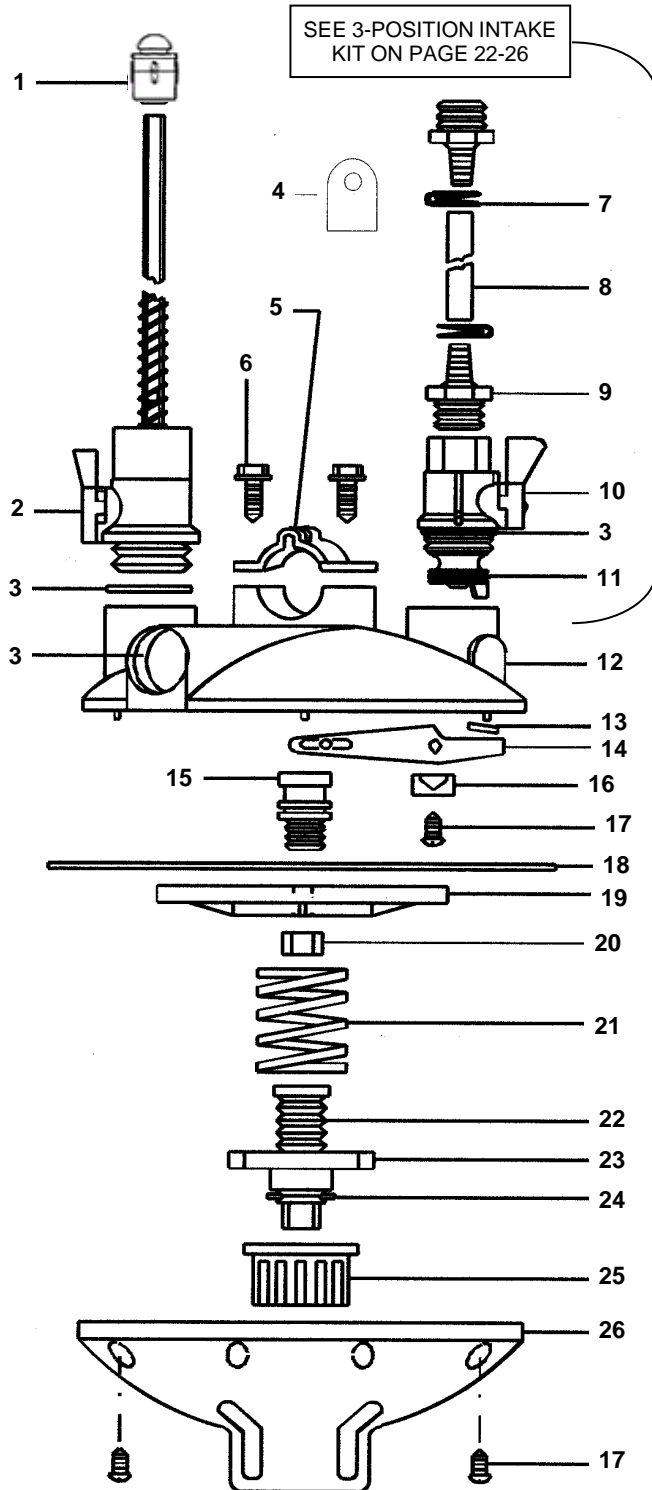

KEY	PART #	DESCRIPTION
1	820295	TruSeal Cap for Flex Standpipe
2		Standpipe - See page 22-05
3	VO145	O-Ring for 3/4" Couplings
4	VRP42	(2) Mounting Brackets for Aluminum Extrusion
5	VRP06	Pipe Clamp
6	VRP05-1	Screws for Pipe Clamp & Filter Bracket
7	VF204C	Hose Clamp for 3/8" Urethane
8	VRP48	PVC Yellow Reinforced Hose 3/8" 200 PSI (Drop Hose)
9	VRP45	1/2" Threaded Male Hose Connector (3/8" Barb)
10	VRP09	1/2" NPT Intake with Shutoff
	VRP09L	1/2" NPT Low Press Intake with S/O
11	VRP119	O-Ring for Bottom of RVH114
12	VRP11	Top Housing
13	VRP36G	Rubber Wafer Replacement
14	VRP12G	Pivot - New Style
15	VRP15	Diagram Bolt
16	VRP13	Pivot Brackets (Multiples of 2)
17	VRP14	Screw - 2 for Bracket or 9 for Bottom Housing
18	VRP16	Diaphragm
19	VRP52	Diaphragm Plate
20	VRP18	Diaphragm Nut
21	VRP19	Spring
22	VRP20	Adjustment Bolt
23	VRP25	Adjustment Collar
24	VRP21	Adjustment Bolt Pin
25	VRP24	Adjustment Knob
26	VRP22	Bottom Housing

VR-202 V-MAX REGULATOR WITH RFV160K 3-POSITION INTAKE

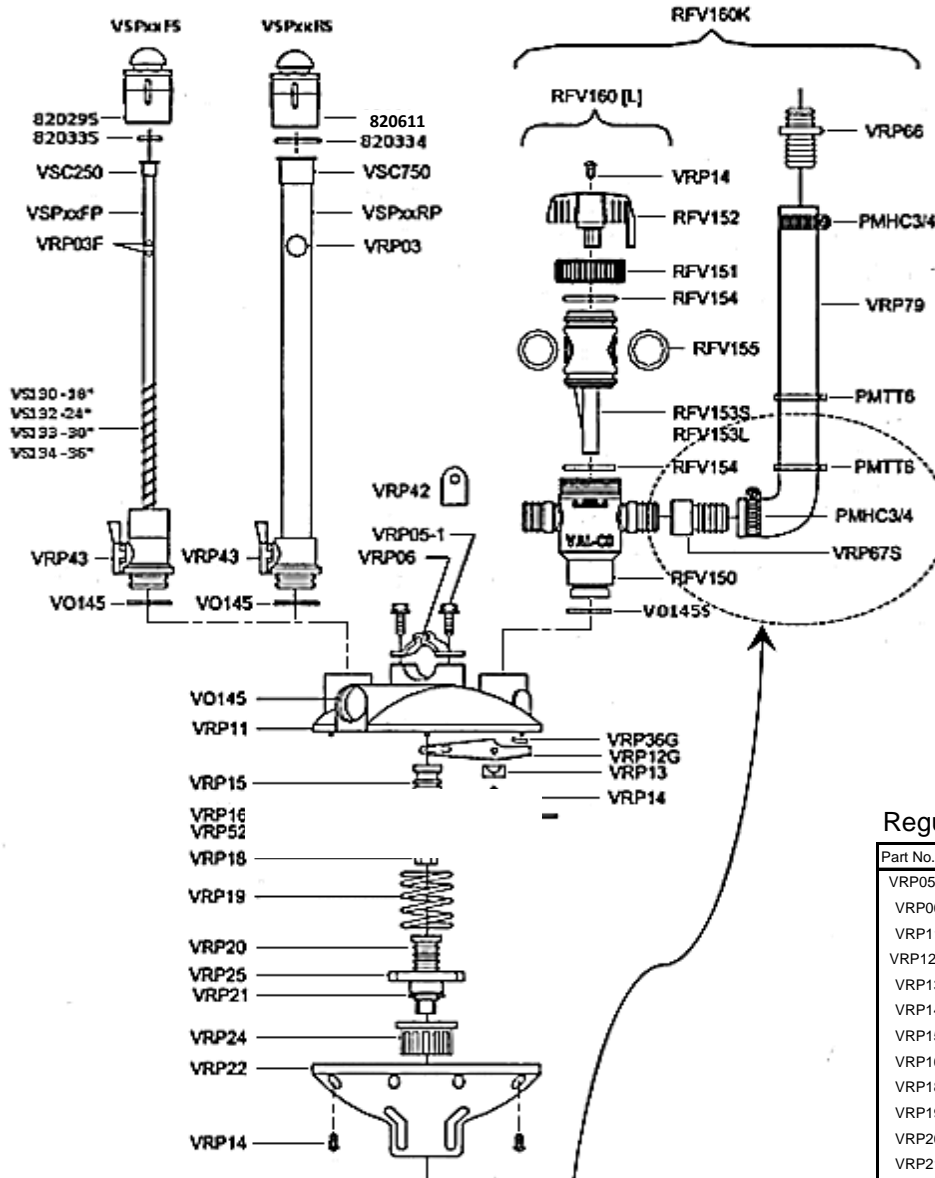

IMPORTANT!
 SEE PAGE 22-28 FOR PROPER
 INSTALLATION OF REGULATOR WITH
 RFV160K 3-POSITION INTAKE.

Part No.	Description
RFV160K	Regulator Flushing Intake Kit
RFV160	Regulator Flushing Intake Only
RFV150	Flushing Intake Housing
RFV151	Flushing Intake Cap
RFV152	Flushing Intake Handle
RFV153S	Flushing Intake Shaft High Pressure
RFV153L	Flushing Intake Shaft Low Pressure
RFV154	(2) Large O-Ring for RFV153
RFV155	(2) Small O-Ring for RFV153
VRP79	3/4" ID Yellow Hose
VRP66	3/4" Barb x 1/2" Male NPT
VRP67S	3/4" Barb x 3/4" Female NPT
PMHC3/4	(2) 3/4" Hose Clamp
VO145S	O-Ring for RFV150
PMTT6	(2) Wire Ties
VSPxxRS	xx" Rigid SP w/ Shutoff Ball & TruSeal
VRP03	Blue Rigid Standpipe Ball
VRP43	Shutoff for Standpipe
VSPxxRP	xx" Rigid SP Tube Only
820334	Rigid TruSeal Seal
820611	Rigid TruSeal
VO145	O-Ring for 3/4" Couplers
VSPxxFS	xx" Flex SP w shutoff Ball Y& TruSeal
VRP43	Shutoff for Standpipe
VS130	Spring for 18" Flex Standpipe
VS132	Spring for 24" Flex Standpipe
VS133	Spring for 30" Flex Standpipe
VS134	Spring for 36" Flex Standpipe
VSPxxFP	xx" Flex SP Tube Only
820335	Flex Truseal Seal
820295	Flex Truseal
VO145	O-Ring for 3/4" Couplers

Regulator Body 12002

Part No.	Description
VRP05-1	(2) Screws for Pipe Clamp/ Filter Bracket
VRP06	(1) Pipe Clamp
VRP11	Top Housing, VR202 Regulator
VRP12G	Pivot
VRP13	(2) Pivot Brackets - must purchase in multiples of 2
VRP14	Screws (2) Pivot Brackets & (9) Bottom Housing (1) Intake
VRP15	Diaphragm Bolt
VRP16	Diaphragm
VRP18	Diaphragm Nut
VRP19	Spring
VRP20	Adjustment Bolt
VRP21	Adjustment Bolt Pin
VRP22	Bottom Housing, VR202 Regulator
VRP24	Adjustment Knob
VRP25	Adjustment Collar
VRP36G	Seal
VRP42	(2) Mounting Bracket for Aluminum Extrusion
VRP52	Diaphragm Plate

CORRECT INSTALLATION WITH RFV160K 3-POSITION INTAKE

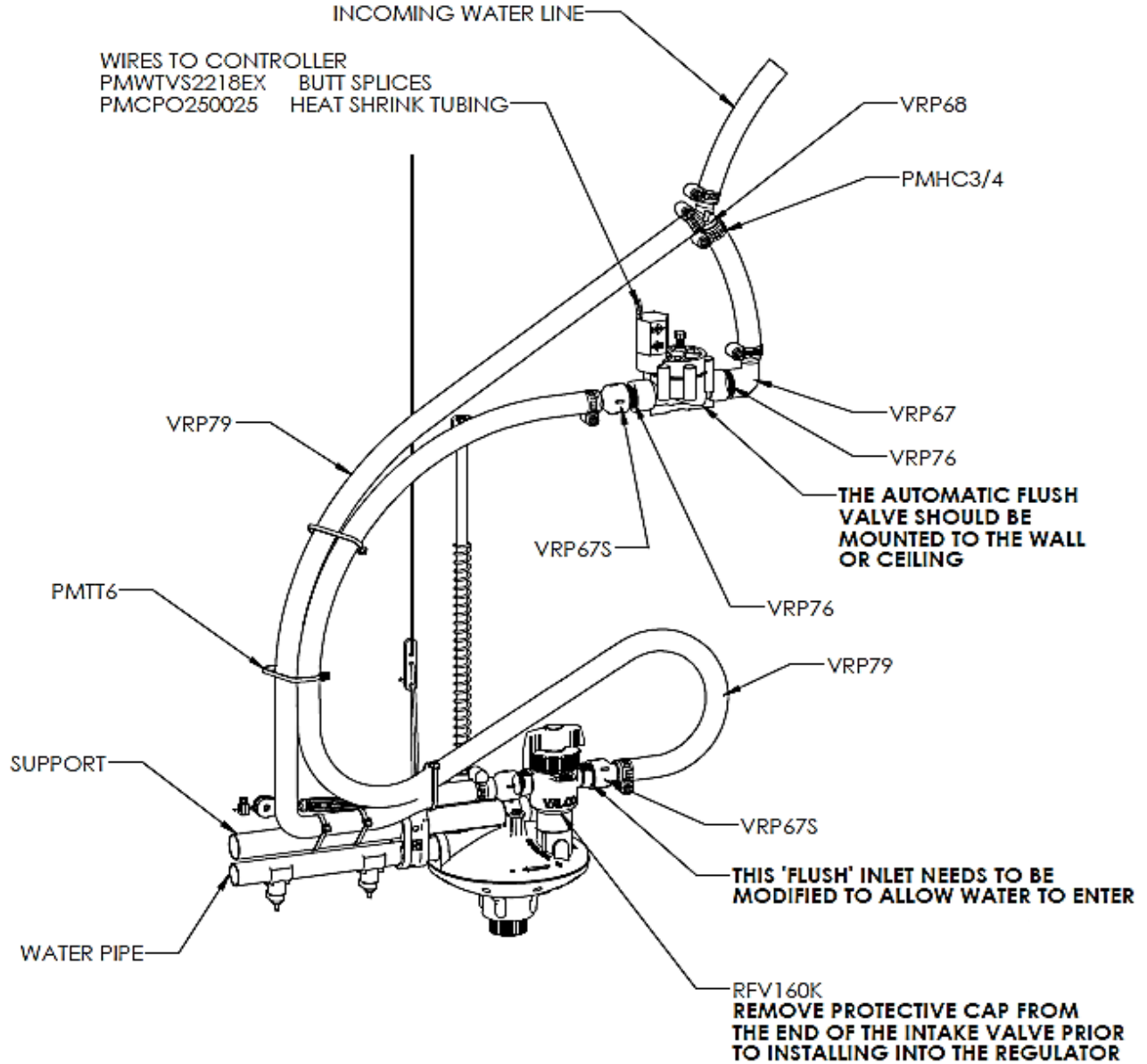

Part Number	Description	Ship Weight		List Price
		LBS.	KG.	
VRP67	#REF!	0.06	0.03	
VRP67S	#REF!	0.05	0.02	
VRP68	#REF!	0.05	0.02	
VRP76	#REF!	0.03	0.01	
VRP79	#REF!	0.22	0.10	
PMTT6	#REF!	0.00	0.00	
PMHC3/4	#REF!	0.04	0.02	

3-POSITION FLUSHING INTAKE

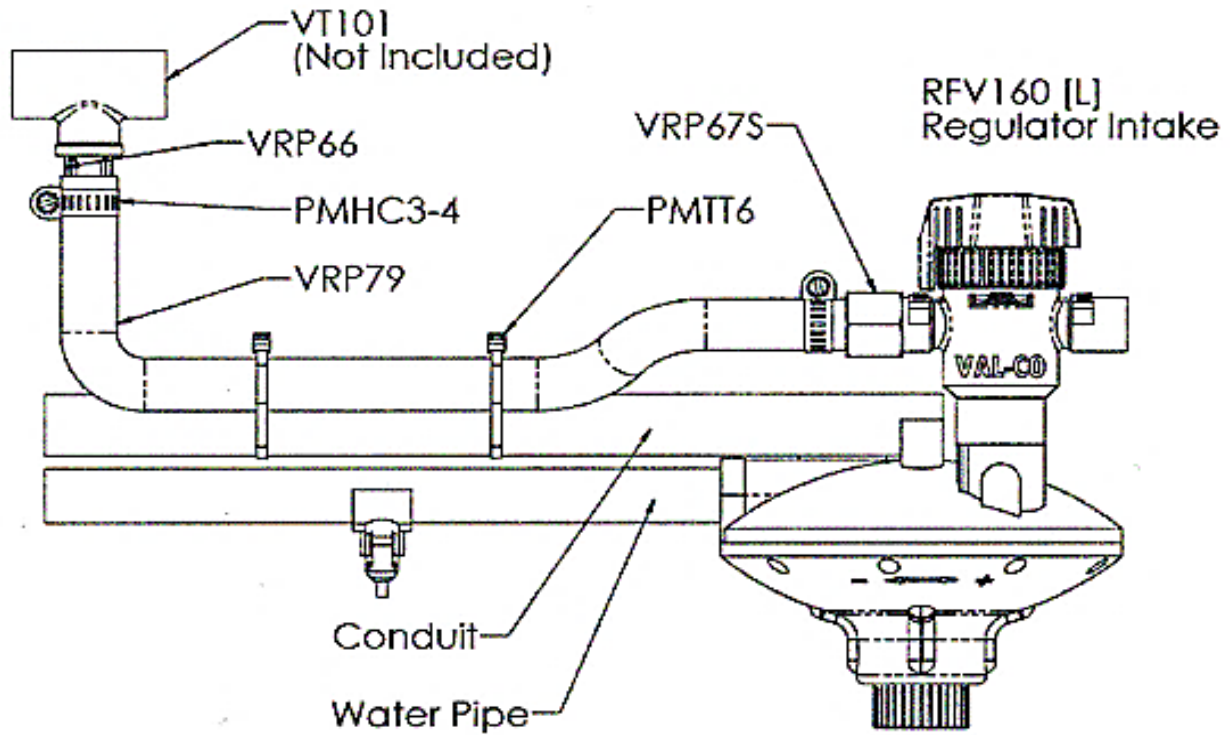

INTAKE POSITIONS

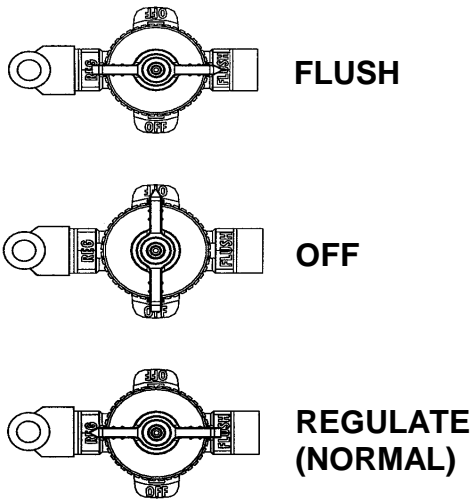

Also reference RFV160K drawing on page 22-26

PART #	DESCRIPTION
RFV160	3-Position Intake
RFV160L	3-Position Intake (Low Pressure)
VRP66	3/4" Barb x 1/2" Male NPT Straight Fitting
VRP79	3/4" ID Yellow Hose - Per Foot
PMHC3/4	3/4" Hose Clamp (2 req'd)
VRP67S	3/4" Barb x 3/4" Female NPT
VT101	PVC Tee
PMTT6	7.5" Black Wire Tie

VR-203 V-MAX REGULATOR

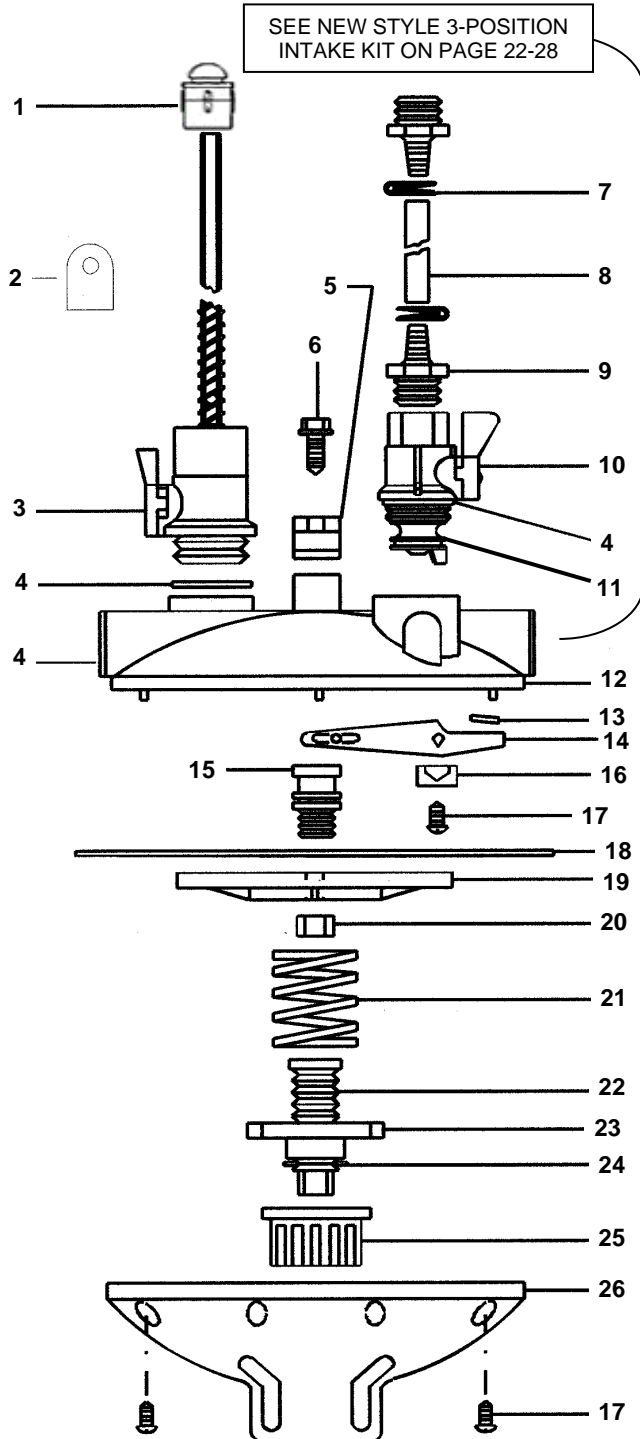

KEY	PART #	DESCRIPTION
1	820295	TruSeal Cap for Flex Standpipe
2	VRP42	(2) Mounting Brackets for Aluminum Extrusion
3		Standpipe - See page 22-05
4	VO145	O-Ring for 3/4" Couplings
5	VRP06	Pipe Clamp
6	VRP05-1	Screws for Pipe Clamp & Filter Bracket
7	VF204C	Hose Clamp for 3/8" Urethane
8	VRP48	PVC Yellow Reinforced Hose 3/8" 200 PSI (Drop Hose)
9	VRP45	1/2" Threaded Male Hose Connector (3/8" Barb)
10	VRP09	1/2" NPT Intake with Shutoff
	VRP09L	1/2" NPT Low Press Intake with S/O
11	VRP119	O-Ring for Bottom of RVH114
12	VRP23	Top Housing
13	VRP36G	Rubber Wafer Placement
14	VRP12G	Pivot - New Style
15	VRP15	Diaphragm Bolt
16	VRP13	Pivot Brackets (Multiples of 2)
17	VRP14	Screw - 2 for Pivot Bracket or 9 for Bottom Housing
18	VRP16	Diaphragm
19	VRP52	Diaphragm Plate
20	VRP18	Diaphragm Nut
21	VRP19	Spring
22	VRP20	Adjustment Bolt
23	VRP25	Adjustment Collar
24	VRP21	Adjustment Bolt Pin
25	VRP24	Adjustment Knob
26	VRP22	Bottom Housing

VR-204 V-MAX REGULATOR

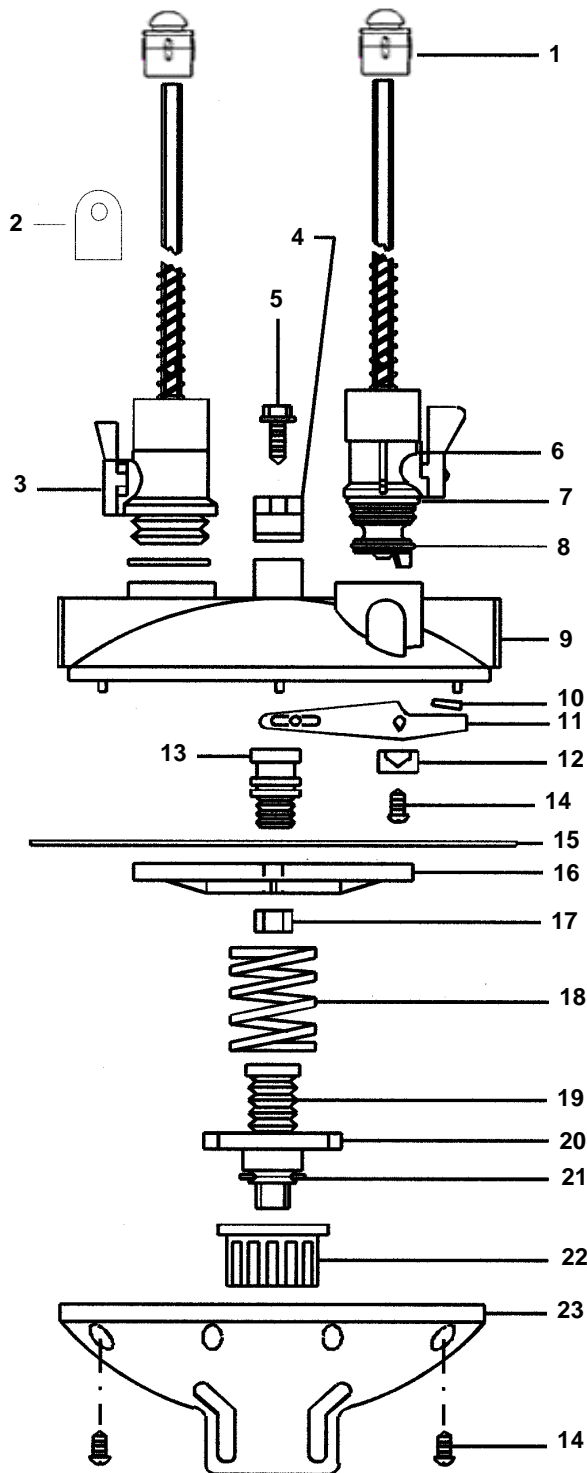

KEY	PART #	DESCRIPTION
1	820295	TruSeal Cap for Flex Standpipe
2	VRP42	(2) Mounting Brackets for Aluminum Extrusion
3		Standpipe - See page 22-05
4	VRP06	Pipe Clamp
5	VRP05-1	Screws for Pipe Clamp & Filter Bracket
6		Standpipe - See page 22-05
7	VO145	O-Ring for 3/4" Couplings
8	VRP31	O-Ring Seal
9	VRP32	Top Housing
10	VRP36G	Rubber Wafer Replacement
11	VRP12G	Pivot
12	VRP13	Pivot Brackets (Multiples of 2)
13	VRP15	Diaphragm Bolt
14	VRP14	Screw - 2 for Pivot Bracket or 9 for Bottom Housing
15	VRP16	Diaphragm
16	VRP52	Diaphragm Plate
17	VRP18	Diaphragm Nut
18	VRP19	Spring
19	VRP20	Adjustment Bolt
20	VRP25	Adjustment Collar
21	VRP21	Adjustment Bolt Pin
22	VRP24	Adjustment Knob
23	VRP22	Bottom Housing

VR-205 V-MAX REGULATOR

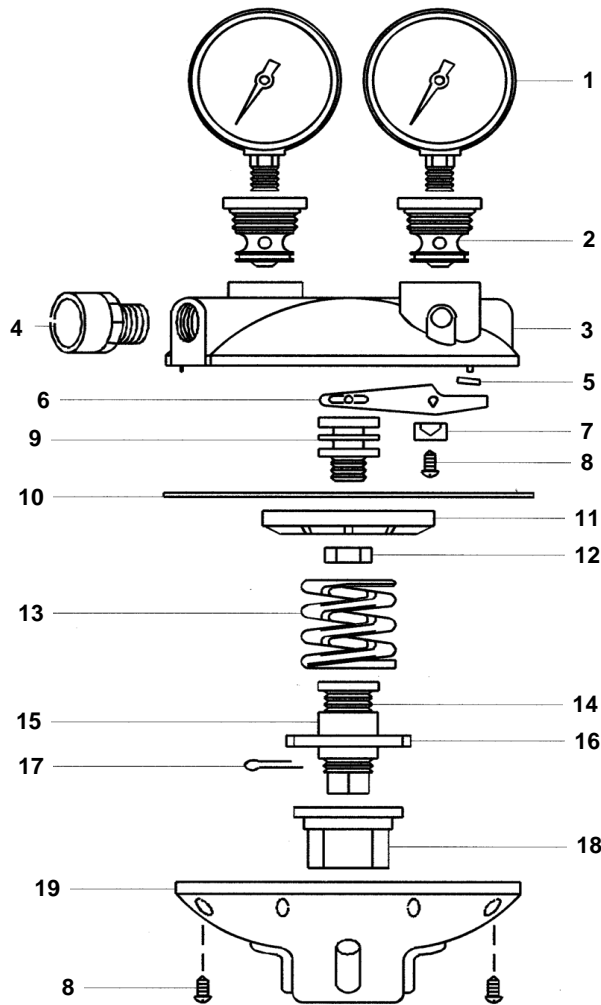

KEY	PART #	
1	VG100	Oil Filled Pressure Gauge (0-100 PSI)
2	VRP57	Gauge Intake
3	VRP58	Top Housing
4	VT131	3/4" PVC Male Adapter SX thread
5	VRP36G	Rubber Wafer Replacement
6	VRP12G	Pivot - New Style
7	VRP13	Pivot Brackets
8	VRP14	Screw - 2 for Pivot Bracket or 9 for Bottom Housing
9	VRP15	Diaphragm Bolt
10	VRP51	Diaphragm
11	VRP52	Diaphragm Plate
12	VRP18	Diaphragm Nut
13	VRP53	Spring
14	VRP20	Adjustment Bolt Pin
15	VRP50	Diaphragm Spacer
	820224	Diaphragm 1/2 Spacer
16	VRP25	Adjustment Collar
17	VRP21	Adjustment Bolt Pin
18	VRP55	Adjustment Knob
19	VRP54	Bottom Housing

VR209 REGULATOR REPAIRS

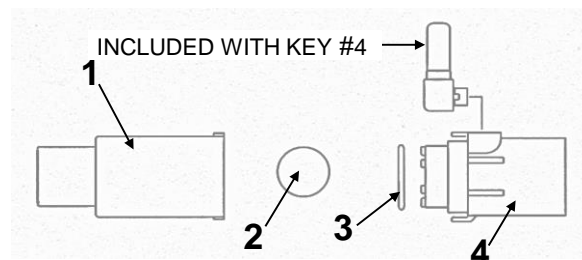

KEY	PART #	ITEM DESCRIPTION	List Price
1	VRP90	Left Housing with Stainless Steel Seat (SS Ball NOT Included) <i>Note: This part may be used in place of Left Housing & Plunger on VR208 Regulator to convert to New Style VR209 Regulator.</i>	
2	VRP94	Stainless Steel Ball Only - 18mm 440CSS, Grade 25	
3	VO145	O-Ring for 3/4" Couplings	
4	VRP78	Right Housing with O-ring	

REGULATOR REPAIRS

NUMERICAL LIST OF REGULATOR REPAIRS		SHIP WEIGHT		LIST PRICE
		LBS.	KGS.	
CATALOG #	ITEM DESCRIPTION			
820295	Auto Shutoff Cap for Flex Standpipe	0.05	0.02	
820611	Auto Shutoff Cap for Rigid Standpipe	0.06	0.03	
820334	Auto Shutoff Cap Replacement Seal for Flex Standpipe	0.00	0.00	
820335	Auto Shutoff Cap Replacement Seal for Rigid Standpipe	0.00	0.00	
PMHC3/4	3/4" Hose Clamp (2 req'd)	0.04	0.01	
PMTT6	7.5" Wire Tie	0.00	0.01	
RFV150	Flushing Intake Housing	0.18	0.08	
RFV151	Flushing Intake Cap	0.05	0.02	
RFV152	Flushing Intake Handle	0.04	0.02	
RFV153L	Flushing Intake Shaft Low Pressure	0.12	0.05	
RFV153S	Flushing Intake Shaft High Pressure	0.12	0.05	
RFV154	(2) Large O-Ring for RFV153	0.00	0.00	
RFV155	(2) Small O-Ring for RFV153	0.00	0.00	
RFV160	3-Position Intake	0.41	0.18	
RFV160L	3-Position Intake (Low Pressure)	0.41	0.18	
VF204C	Hose Clamp for 3/8" Urethane	0.01	0.01	
VG100	Oil Filled Pressure Gauge (0-100 PSI)	0.50	0.23	
VO145	O-Ring for 3/4" Couplings	0.00	0.00	
VO145S	O-Ring for RFV150	0.00	0.00	
VR202RK	Rebuild Kit for VR 202	1.17	0.53	
VRP03	5/8" Blue Rigid Standpipe Ball	0.01	0.00	
VRP03F	5/16 Blue Flex Standpipe Ball	0.00	0.00	
VRP05-1	Screws for Pipe Clamp & Filter Bracket	0.01	0.00	
VRP06	Pipe Clamp	0.06	0.03	
VRP09	1/2" NPT Intake With Shutoff	0.13	0.06	
VRP09L	1/2" NPT Low Press Intake With S/O	0.09	0.04	
VRP11	Top Housing	0.50	0.23	
VRP119	O-Ring for Bottom of RVH114	0.00	0.00	
VRP12G	Pivot - New Style	0.03	0.01	
VRP13	Pivot Brackets (Multiples of 2)	0.00	0.00	
VRP14	Screw - 2 for Bracket or 9 for Bottom Housing	0.00	0.00	
VRP15	Diaphragm Bolt	0.02	0.01	
VRP16	Diaphragm	0.12	0.06	
VRP18	Diaphragm Nut	0.03	0.01	
VRP19	Spring	0.05	0.02	
VRP20	Adjustment Bolt Pin	0.03	0.01	
VRP21	Adjustment Bolt Pin	0.00	0.00	
VRP22	Bottom Housing	0.47	0.21	
VRP23	Top Housing	0.60	0.27	
VRP24	Adjustment Knob	0.07	0.03	
VRP25	Adjustment Collar	0.03	0.01	

LISTING CONTINUED ON NEXT PAGE

REGULATOR REPAIRS

NUMERICAL LIST OF REGULATOR REPAIRS		SHIP WEIGHT		LIST PRICE
CATALOG #	ITEM DESCRIPTION	LBS.	KGS.	
820334	Seal for VC075	0.00	0.00	
820335	Seal for VC025	0.00	0.00	
820581	Union, 3/4" NPT x 3/4" Socket PVC Fitting	0.16	0.07	
820587	Autoflush Half with Barb	0.67	0.30	
820588	Autoflush Half	0.57	0.26	
VRP30F	Intake With Shutoff (Flex)	0.12	0.05	
VRP31	O-Ring Seal - .867" ID	0.00	0.00	
VRP32	Top Housing	0.61	0.28	
VRP36G	Rubber Wafer Replacement	0.00	0.00	
VRP42	Set of 2 Mounting Brackets for Aluminum Extrusion	0.01	0.00	
VRP45	1/2" Threaded Male Hose Connector (3/8" Barb)	0.01	0.00	
VRP48	PVC Yellow Reinforced Hose 3/8" 200 PSI (Drop Hose)	0.08	0.04	
VRP50	Diaphragm Spacer	0.01	0.01	
VRP51	Diaphragm	0.15	0.07	
VRP52	Diaphragm Plate	0.09	0.04	
VRP53	Spring	0.31	0.14	
VRP54	Bottom Housing	0.45	0.20	
VRP55	Adjustment Knob	0.07	0.03	
VRP57	Gauge Intake	0.04	0.02	
VRP58	Top Housing	0.53	0.24	
VRP66	3/4" Barbed x 1/2" Male NPT Straight Fitting	0.04	0.02	
VRP67	3/4" Barbed Y Connector	0.06	0.03	
VRP67S	3/4" Barb x Female 3/4" NPT	0.05	0.02	
VRP68	3/4" Barbed Y Connector	0.05	0.02	
VRP76	3/4" Close Nipple Plastic	0.03	0.01	
VRP79	3/4" ID Yellow Hose - Per Foot	0.22	0.10	
VRP90	Left Housing With Stainless Steel Ball	0.11	0.05	
VRP94	Stainless Steel Ball Only - 18MM 440CSS, Grade 25	0.05	0.02	
VS130	Spring for 18" Flex Standpipe	0.17	0.07	
VS132	Spring for 24" Flex Standpipes	0.23	0.10	
VS133	Spring for 30" Flex Standpipes	0.28	0.13	
VS134	Spring for 36" Flex Standpipes	0.34	0.15	
VSC250	Body Only for VC025	0.00	0.00	
VSC251	Cap Only for VC025	0.00	0.00	
VSC750	Body Only for VC075	0.01	0.00	
VSC751	Cap Only for VC075	0.01	0.01	
VT131	3/4" PVC Male Adapter SX Thread	0.04	0.02	

FILTER KIT REPAIRS

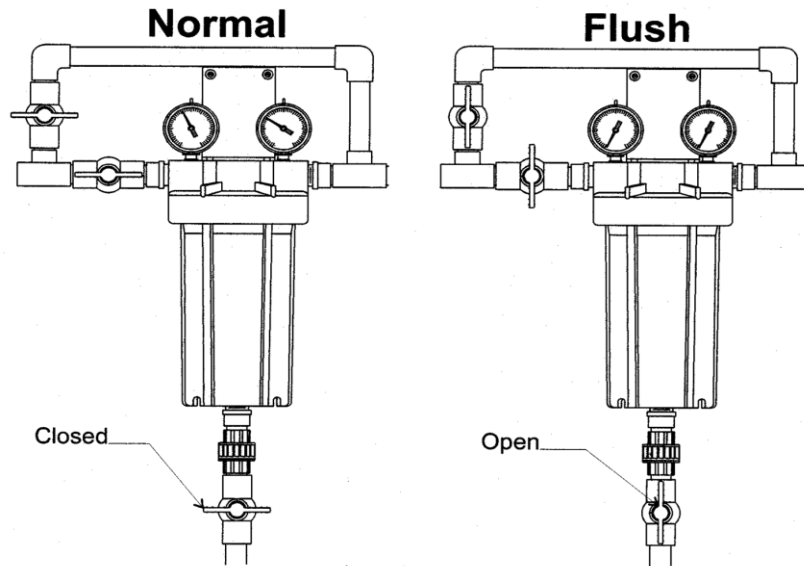

CATALOG NUMBER	ITEM DESCRIPTION	SHIP WEIGHT		LIST PRICE
		LBS.	KGS.	
VF123	Bottom Housing for VF121 and VF122	2.33	1.06	
VF125	O-Ring for VF120 Filter Kit	0.02	0.01	
VF126	O-Ring for VF121 and VF122 Filter Kit	0.02	0.01	
VF128	Filter Bracket (Aluminum)	0.79	0.36	
VF129	Lid for Filter	1.90	0.86	
VG100	Oil Filled Pressure Gauge (0-100 PSI)	0.50	0.23	
VG100L	Oil Filled Pressure Gauge (0-15 PSI)	0.45	0.20	
VM121-10	Reusable Filter Cartridge for VF121/VF122 (10 Micron) - Blue Dot	1.91	0.87	
VM121-30	Filter Cart. Poly - Fibrillated VF121/122 (30 Micron) - Black Dot	1.50	0.68	
VM121-50	Filter Cart. Poly - Fibrillated VF121/VF122 (50 Micron) - Red Dot	1.62	0.73	
VT131	3/4" PVC Male Adapter S X Thread	0.04	0.02	
VT141	1" PVC Male Adapter 1" Thread X 3/4" S	0.01	0.00	
VX127	3/4" Union S X S	0.16	0.07	